



Research Article

Thermal performance of cocoa pod cook stove

Anak Agung PUTU SUSASTRIAWAN^{1,*}, Yuli PURWANTO¹, Bambang Wahyu SIDHARTA¹,
Noval SIOLIMBONA¹

¹Department of Mechanical Engineering, Institut Sains dan Teknologi AKPRIND Yogyakarta, 55222, Indonesia

ARTICLE INFO

Article history

Received: 08 May 2022

Accepted: 22 June 2022

Keywords:

Cocoa Pod; Gasifier; Stove;
Utilization; Waste

ABSTRACT

Indonesia produces approximately 550.000 ton/year of cocoa pod waste from chocolate industry. The waste has a good potential to be used as a biomass feedstock of a cook stove. However, thermal performance of the conventional cook stove is low when using a high moisture content feedstock, such as a cocoa pod waste. In addition, conventional cook stove generates high pollutant when high moisture content feedstock is used. In other to encounter the problems, the present work develops gasifier based cocoa pod cook stove and investigates thermal performance of the stove at various equivalence ratios. The data collection is performed by varying equivalence ratio at 0.4, 0.5, and 0.6. Temperature of the stove, flame image, flame temperature, and water temperature are collected and used to analyze the thermal performance (i.e. useful heat and thermal efficiency) of the stove. The results reveal that a waste of cocoa pod can be used as a feedstock of gasifier based cook stove. Maximum useful heat of 1337.6 kJ and maximum thermal efficiency of 3.5% are obtained at optimum equivalence ratio of 0.5. To improve performance of the stove, the cocoa pod waste should be sun dried to reduce its moisture content and the porous burner may be applied as a burner of the gasifier based cook stove in the future work.

Cite this article as: Putu Susastriawan AA, Purwanto Y, Sidharta BW, Siolimbona N. Thermal performance of cocoa pod cook stove. J Ther Eng 2024;10(1):188–195.

INTRODUCTION

Utilization of biomass waste as a renewable energy source increases significantly in last decade. Corresponding to Jain & Sheth [1], 1/7 world energy demand is supplied by biomass energy. Various wastes of biomass has been explored as a feedstock of a cook stove as well as a feedstock of gasifier. Typically, those wastes are classified as woody biomass and non woody biomass. Woody biomasses have been utilized as feedstock are pine wood [2, 3], beech

wood [4], and eucalyptus wood [5]. Meanwhile, non woody biomasses have been used as feedstock are oil palm kernel shells [6,7], rice husk [8, 9], wood sawdust [10], de-oiled Pongamia pinnata seed cake [11], municipal solid waste [12]. In cooking stove, feedstock is directly burnt to generate flame and heat. While, the feedstock is converted to a producer gas in gasifier through thermo-chemical gasification process. The gas can be applied as a fuel of a burner as well as internal combustion (IC) engine. Producer gas

*Corresponding author.

*E-mail address: agung589E@akprind.ac.id

This paper was recommended for publication in revised form by Regional Editor Omid Mahian



can be burnt directly in the burner to generate heat. But, tar and solid particle removal is required when the gas is intended for internal combustion (IC) engine [13-15]. Tar can stick on fuel line system and may damage the fuel line. When intended for engine fuel, maximum tar content of a producer gas is 100 mg/Nm³ [16].

Indonesia itself has biomass energy potential about 32.65 GW, but unfortunately only 5.1% has been utilized [17]. This biomass energy potential comes from various sources, such as from cocoa plantation. Indonesia produce in average of 750,000 ton cocoa fruit per year in last decade. Seeds of the fruit are used for making chocolate powder and the pods are disposed. Figure 1 shows an anatomy of cocoa fruit which is 73.63% pod, 23.37% seed, and 2% placenta [18]. This means that approximately 550.000 ton of cocoa pod is disposed in a year which is a huge potential as a feedstock of gasification based cooking stove. Beside availability, cocoa pod also has a suitable ultimate property and heating value as a feedstock. Table 1 represents typical ultimate property and higher heating value (HHV) of a cocoa pod. The values of the properties may differ depending on the origin place of the pod.

Gasification based stove is promising technology in converting biomass waste into a producer gas fuel since producer gas combustion is cleaner than biomass direct combustion. Many gasifier based stoves have been developed

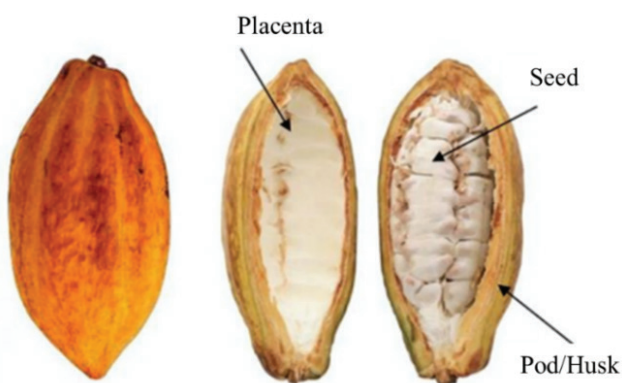

Figure 1. Anatomy of a cocoa fruit.

Table 1. Typical values of ultimate properties and HHV of cocoa pod [19]

Ultimate property	Cocoa pod
C (wt.%)	43.87 - 48.70
H (wt.%)	0.75 - 5.84
O (wt.%)	37.20 - 48.39
N (wt.%)	0.17 - 1.19
S (wt.%)	0.17 - 0.97
HHV (MJ/kg)	12.48 - 18.10

and reported previously. A 2.5 kW gasifier stove having a 80% efficiency has been fabricated by Sutar *et al.* [20]. They stated that reaction surface area and reactor temperature play an important role to stove's performance. Meanwhile, an effect of biomass type on performance of the top lit up-draft (TLUD) gasifier stove was reported by Tryner *et al.* [21]. They stated that biomass type causes variation in stove's performance substantially. Compared to traditional stove, the TLUD gasifier stove has better performance [22]. The different of working principle between gasifier stove and conventional stove can be explained by Figure 2. In a traditional stove, excess air is required for direct combustion of the feedstock, heat and flue gas are the product. In contrast, gasifier based cook stove requires only small amount of air (deficient air) for gasification and generates a producer gas. The producer gas flows upward to the burner in which producer gas combustion occurs, generates producer gas flame and heat for cooking.

Combustible gas carbon monoxide (CO), hydrogen (H₂), and methane (CH₄) dictates energy density of a producer gas. The higher the combustible gas content, the higher the energy density. Energy content of the producer gas in terms of heating value is affected by several factors, i.e. air flow rate. The amount of air used for gasification is generally defined as equivalence ratio. Effective equivalence ratio for biomass gasification lies between 0.2 and 0.4 [23]. Increasing equivalence ratio leads to improve oxidation rate, releases more heat, and results in rising gasification temperature [24]. Gasification temperature increase as equivalence ratio steps up which causes improvement in gas heating value. Gas heating value increases with increasing gasification temperature due to more H₂ and CO generate with the rising of gasification temperature [25]. Generally, biomass gasification generates a low heating value producer gas, such that 3800–4232 kJ/.kg which are difficult to be

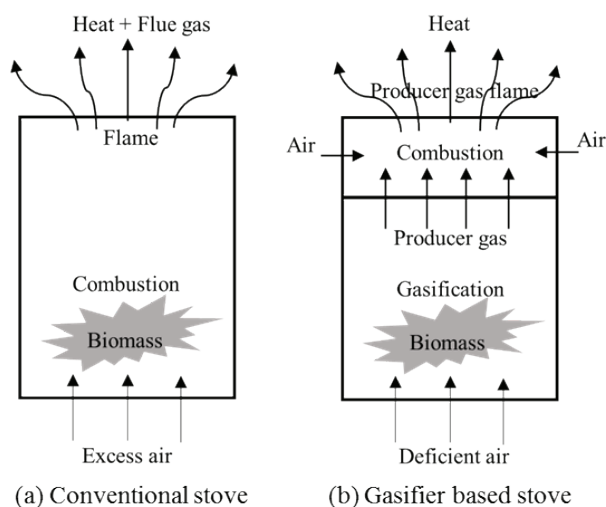

Figure 2. Schematic diagram of conventional and gasifier based cook stove.

burnt in conventional burner [26]. Low heating value fuel commonly produces low flame temperature that beneficial in thermal nitric oxide (NO_x) reduction [27]. However, a low heating value fuel has narrow flammability limits and lack of flame stability [28].

From literatures have been studied and cited, it can be stated that high moisture content feedstock such as cocoa pod waste generates low heating value producer gas during gasification. Stable flame of low heating value producer gas in the burner is difficult to be achieved, hence low thermal performance of the stove. Gasification problem of high moisture content feedstock may encounter by increasing air flow rate, i.e. equivalence ratio. Thus, the objective of the present work is to develop gasification based cocoa pod cook stove and investigate an effect of equivalence ratio (0.4, 0.5, and 0.6) on thermal performance (useful heat and thermal efficiency) of the stove. No work in exploring a cocoa pod waste as a feedstock of cook stove has been performed and reported so far.

METHODOLOGY

Design and Fabrication

Figure 3 presents the detail design of the gasifier based stove. The stove is made from Mild steel pipe with 3 mm thickness. The stove has inner diameter of 500 mm, gasifier height of 600 mm, and total height of 1000 mm. Hopper for feeding the feedstock has a diameter of 180 mm. Air for gasification is supply into the gasifier through air inlet. Ash of the gasified feedstock is removed from the stove through ash outlet. Producer gas generated is flamed in the burner to generate producer gas flame and heat.

Feedstock Preparation

Feedstock preparation is started by collecting cocoa pod waste in Kulon Progo Yogyakarta followed by slicing the pod into small pieces and drying the pieces under sunlight for five days. Figure 4 presents a photograph of cocoa pod before and after sun drying. A yellow wet cocoa pod turns a dark brown dry cocoa pod after drying.

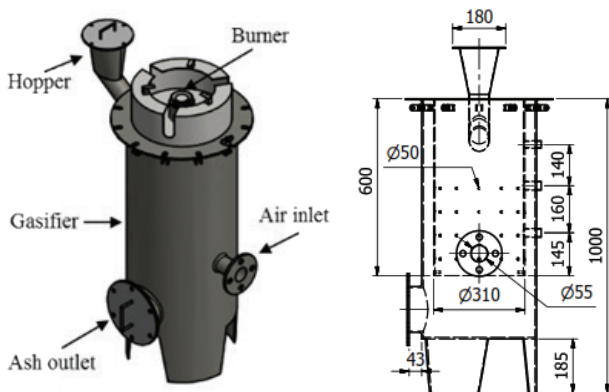

Figure 3. Design of the gasifier based stove.

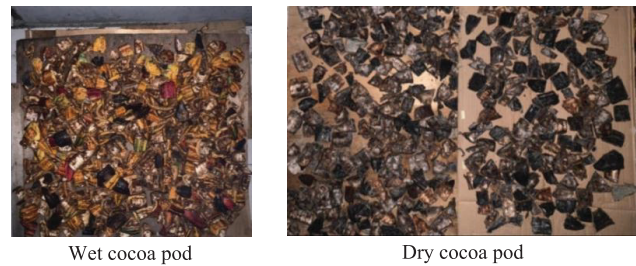

Figure 4. Cocoa before and after drying

Experimental Work

After feedstock preparation, the experimental work is performed. Figure 5 shows the experimental setup of the present work. The stove's performance is tested using Water Boiling Test (WBT) method which is adopted from Chinese WBT method [29]. The setup consists of a gasifier stove, a blower, a burner, a WBT pan, K-type thermocouples, rotameter, and data logger "Graphtec 240". Measurement uncertainty of K-type thermocouple is ± 1 °C. The blower supplies an air for gasification and controlled using the rotameter. K-type thermocouples measure axial temperature of the stove (T_1 , T_2 , and T_3), flame temperature (T_f), and water temperature (T_w) in WBT pan. The T_1 , T_2 , and T_3 are measured at 150 mm, 300 mm, and 450 mm above the grate. The tests are conducted with equivalence ratio of 0.4, 0.5, and 0.6. For each equivalence ratio and the test are repeated three time, the result are then presented in average values. For each test, 3 kg of cocoa pod is used for about 1 hour. The performance of the stove in terms of axial temperature of the stove, flame temperature, mass conversion, useful heat, and thermal efficiency are investigated. Useful heat and thermal efficiency are calculated using Eq. (1) and Eq. (2), respectively [30]

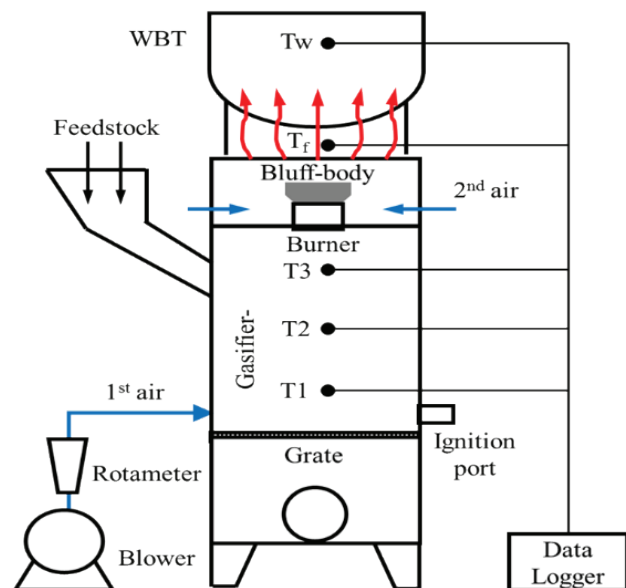

Figure 5. Schematic diagram of the experimental setup.

$$Q = m_w x c_{p,w} x (T_b - T_i) + m_{w,v} x h_{f,g,w} \quad (1)$$

$$\eta = \frac{Q}{m_f \times HHV_f} \times 100\% \quad (2)$$

where m_w is the water weight (kg), $c_{p,w}$ is the water specific heat (4.2 kJ/kg.°C), T_b and T_i are water boiling temperature and initial temperature (°C), $m_{w,v}$ is the water vapor weight (kg), $h_{f,g,w}$ is the water heat of vaporization (2260 kJ/kg), m_f is the weight of the feedstock (kg), HHV_f is the gross calorific value of the cocoa pod (12.48 MJ/kg).

RESULTS AND DISCUSSION

Figure 6 displays an influence of equivalence ratio on axial temperature of the stove. Temperature at lower part of the stove, i.e. 150 mm above the grate, is the highest for all equivalence ratios observed. The highest temperature at this location indicates that oxidation occurs at this zone since air is supplied from the bottom and ignition port is located near the grate. Heat released by oxidation is transferred upwards to gasification zone $T_2 - T_3$ (300 mm – 450 mm above the grate), hence temperature T_2 and T_3 increase

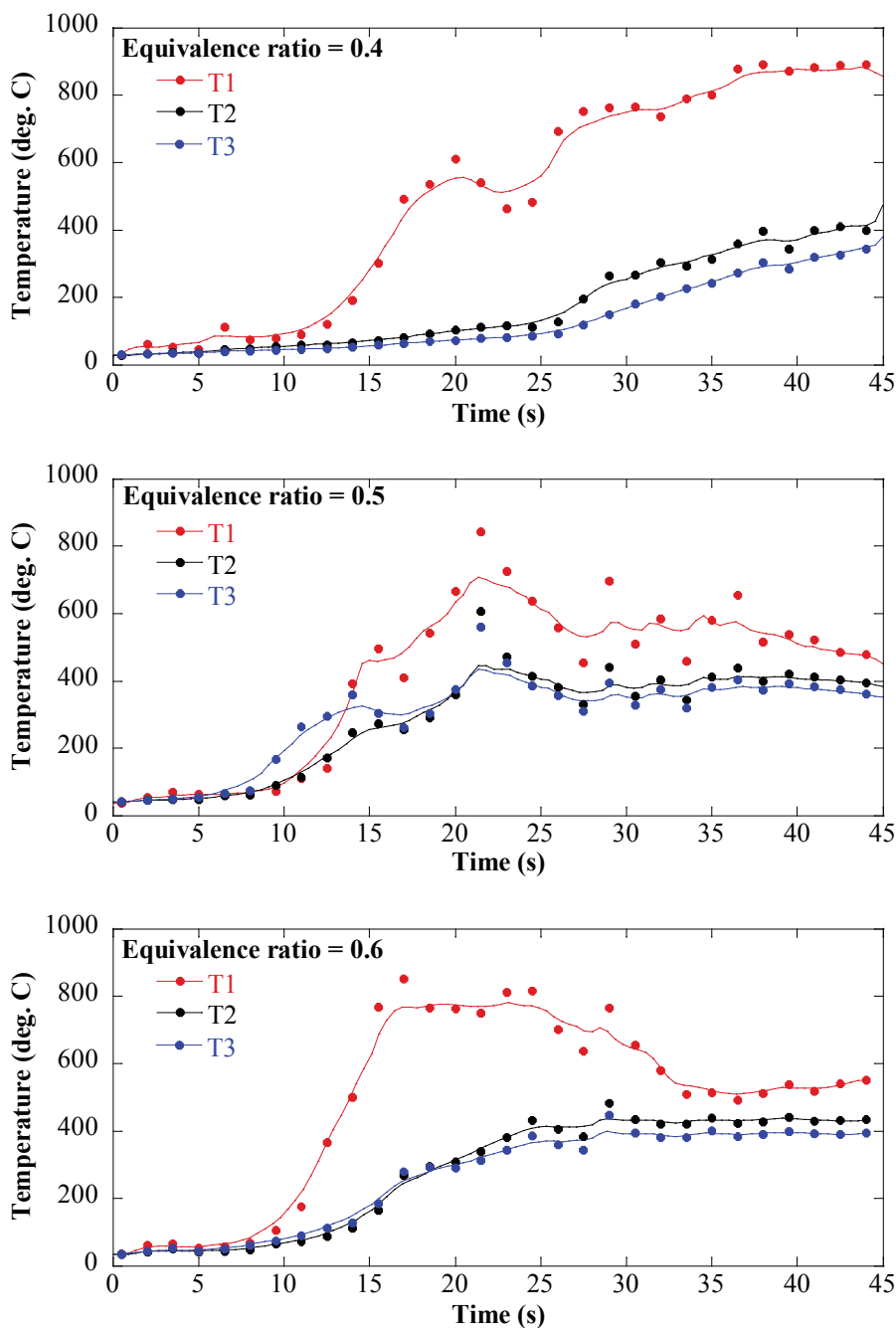
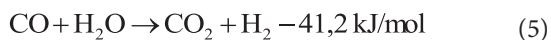
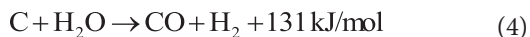
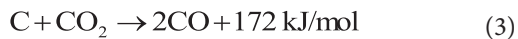

Figure 6. Axial temperature distribution of the stove

till reach gasification temperature, i.e. 400°C. Gasification take place at height between 300 mm and 450 from the grate, forms combustible gas (CO, H₂, and CH₄) as well as non-combustible gas carbon dioxide (CO₂) and nitrogen (N₂). Combustible gas generates through Boudouard reaction (Eq. 3), Water Gas reaction (Eq. 4), Water Gas shift reaction (Eq. 5), and methane reaction ((Eq. 6) [31]. Increasing gasification temperature may crack more tar into combustible gas CO and H₂ [25], hence heating value of the producer gas increases.



From Figure 6, it can be observed that increasing temperature of T1 is faster at higher equivalence ratio. More amount of air is supplied to the oxidation zone at higher equivalence ratio, which means that more oxygen available for oxidation. This leads to faster oxidation process and more heat is released, hence temperature T1 increases faster. Similar trend of temperature T1 and T2 are found. Since heat releasing by oxidation process at equivalence ratio 0.5 is faster than that at equivalence 0.4, the temperature of

gasification zone T2 and T3 also step up faster at equivalence ratio 0.5. The gasification temperatures (i.e. 400°C) are reached after 30 minutes for equivalence ratio 0.4 and after 20 minutes for equivalence ratio 0.5. However, the reaching of gasification temperature get slower when equivalence ratio increases to 0.6, even though the increasing of temperature T₁ is the fastest. This phenomenon is due to more heat is blown out to a burner that reducing heat adsorption rate by a feedstock in gasification zone and obviously slowing down temperature increasing of gasification zone.

Figure 7 presents a photograph of a flame at 25 minute of WBT test. Red flame is observed for the use of 0.4 equivalence ratio. Red color flame indicates that tar content of producer gas is high. Combustion of a producer gas with high tar content generates red color flame. The flame turns to blue flame when equivalence ratio boosts to 0.5 and 0.6. This may due to increasing hydrogen content of producer gas, since increasing equivalence ratio causes enhancing tar cracking and combustible gas forming.

Figure 7 also displays flame temperature profile and water temperature profile during the test. Typically, cocoa pod flame has a temperature about 400°C. The fastest increasing flame temperature occurs at 0.5 equivalence ratio as can be shown in the figure. Flame temperature of 400°C is reached at 10 minutes for 0.5 equivalence ratio and after 18 minutes for equivalence ratio of 0.4 and 0.6. Similar trend with flame temperature increasing, the fastest

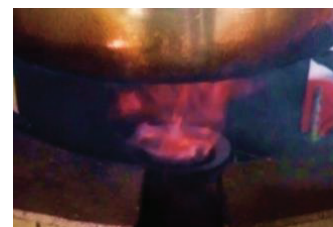

Ø = 0.4



Ø = 0.5



Ø = 0.6

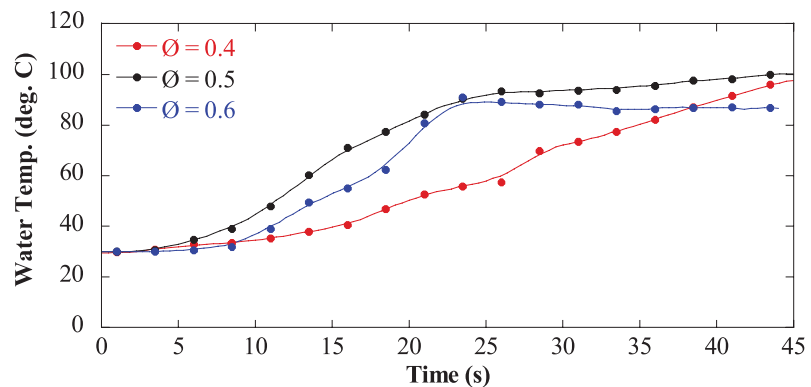
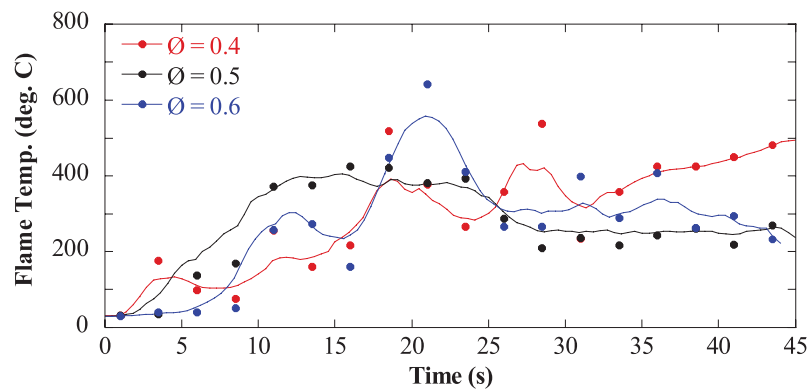

Figure 7. Flame image, flame temperature, and water temperature.

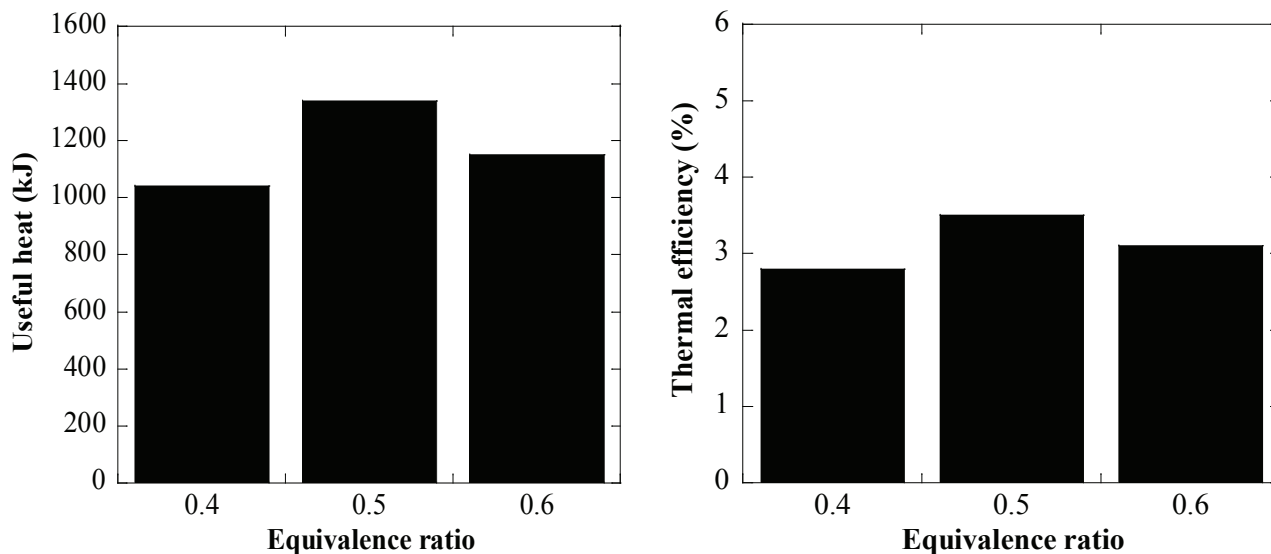

Figure 8. Useful energy and thermal efficiency.

increasing temperature of water is also observed at 0.5 equivalence ratio. Based on flame color, it can be observed that blue color flame heats water in the WBT pan faster than by red color flame. It might be a blue color flame has a higher heating value than a red color flame.

Meanwhile, Figure 8 displays an effect of equivalence ratio on useful heat and thermal efficiency. It can be investigated that the highest useful heat occurs at equivalence ratio of 0.5. The blue and stable flame generated at equivalence ratio of 0.5 tends to increase heat transfer to the water in the pan, hence enhancing useful heat. Useful heat for equivalence ratio of 0.4, 0.5, and 0.6 are 1041.7, 1337.6, and 1151.8 kJ, respectively. Since thermal efficiency is proportional to useful energy, thus the highest thermal efficiency is observed at equivalence ratio 0.5. The thermal efficiencies are 2.8, 3.5, and 3.1% at equivalence ratio of 0.4, 0.5, and 0.6, correspondingly.

The maximum thermal efficiency of the present work (i.e. 3.5%) is compared with other previous similar works performed by Tryner *et al.* [21], Obi *et al.* [22], and Parmigiani *et al.* [32] in Figure 8. Compared with other work, the thermal efficiency of the present work is lower than those previous works as shown by Figure 8. The previous works obtained thermal efficiency of 40% [21], 9% [22], and 18% [32]. Lower thermal efficiency of the present work is due to high moisture content of the cocoa pod used as feedstock of the stove. More heat from oxidation is used for drying process during gasification in which reduces heat availability for reduction process. Thus, less combustible gas is generated during gasification, i.e. low calorific value producer gas. In order to improve thermal efficiency of the stove, it requires redesign of a burner that suitable for low calorific value producer gas. For example, the porous burner developed by Jirakulsomchok, *et al.* [26] may be

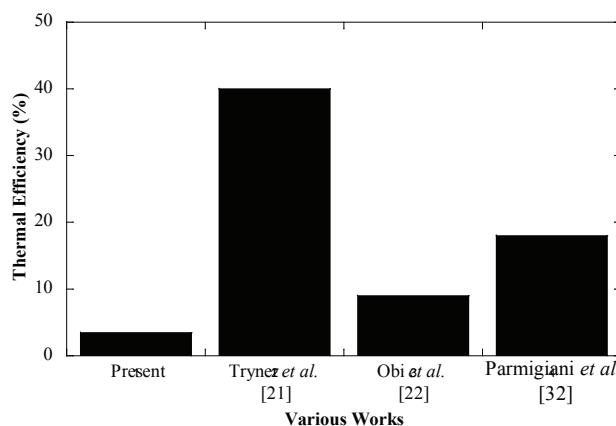

Figure 9. Comparison of thermal efficiency with other works.

adopted in redesigning a burner of the gasification based cook stove.

Although the thermal efficiency of the cocoa pod stove is low, but utilization of the pod as energy source is valuable effort in reducing cocoa pod waste deposit on the land and also give carbon credit to the environment. By assuming all cocoa pod waste produced a year (i.e. 500.000 ton) is used as a feedstock of the cook stove and taking carbon content of the pod is 48% (Table 1), it broadly implies that the utilization of cocoa pod as energy source able to reduce carbon emission to the land about 240.000 ton a year.

CONCLUSION

The gasifier based cook stove for feedstock of cocoa pod waste has been successfully fabricated and test at

equivalence ratio of 0.4, 0.5, and 0.6. It can be concluded that a waste of cocoa pod can be used as a feedstock of gasifier based cook stove. The performance (useful heat and thermal efficiency) of the stove is affected by equivalence ratio. In the present work, optimum equivalence ratio of 0.5 give maximum useful heat of 1337.6 kJ and maximum thermal efficiency of 3.5. For future work, it requires redesign of a burner that suitable for low heating value producer gas and investigate maximum allowable moisture content of the cocoa pod in order to obtain high thermal efficiency of the stove.

ACKNOWLEDGEMENT

The authors would like to thank Department of Mechanical Engineering Institut Sains dan Teknologi AKPRIND for the support given during the work.

AUTHORSHIP CONTRIBUTIONS

Authors equally contributed to this work.

DATA AVAILABILITY STATEMENT

The authors confirm that the data that supports the findings of this study are available within the article. Raw data that support the finding of this study are available from the corresponding author, upon reasonable request.

CONFLICT OF INTEREST

The author declared no potential conflicts of interest with respect to the research, authorship, and/or publication of this article.

ETHICS

There are no ethical issues with the publication of this manuscript.

REFERENCES

- [1] Jain T, Sheth PN. Design of energy utilization test for a biomass cook stove: Formulation of an optimum air flow recipe. *Energy* 2019;166:1097–1105. [\[CrossRef\]](#)
- [2] Hu J, Jia Z, Zhao S, Wang W, Zhang Q, Liu R, Huang Z. Activated char supported Fe-Ni catalyst for syngas production from catalytic gasification of pine wood. *Bioresour Technol* 2021;340:125600. [\[CrossRef\]](#)
- [3] Li J, Burra KG, Wang Z, Lu X, Gupta K. CO₂ assisted gasification of ion-exchanged pine wood. *Fuel* 2022;317:123549. [\[CrossRef\]](#)
- [4] Liakakou ET, Infantes A, Neumann A, Vreugdenhil BJ. Connecting gasification with syngas fermentation: Comparison of the performance of lignin and beech wood. *Fuel* 2021;290:120054. [\[CrossRef\]](#)
- [5] Parrillo F, Ardolino F, Cali G, Marotto D, Pettinau A, Arena U. Fluidized bed gasification of eucalyptus chips: Axial profiles of syngas composition in a pilot scale reactor. *Energy* 2021;219:119604. [\[CrossRef\]](#)
- [6] Barco-Burgos J, Carles-Bruno J, Eicker U, Saldana-Robles AL, Alcántar-Camarena V. Hydrogen-rich syngas production from palm kernel shells (PKS) biomass on a downdraft allothermal gasifier using steam as a gasifying agent. *Energy Convers Manag* 2021;245:114592. [\[CrossRef\]](#)
- [7] Yahaya AZ, Somalu MR, Muchtar A, Sulaiman SA, Wan Daud WR. Effect of particle size and temperature on gasification performance of coconut and palm kernel shells in downdraft fixed-bed reactor. *Energy* 2019;175:931–940. [\[CrossRef\]](#)
- [8] Susastriawan AAP, Saptoadi H, Purnomo. Design and experimental study of pilot scale throat-less downdraft gasifier fed by rice husk and wood sawdust. *Int J Sustain Energy* 2017;6451:1–13. [\[CrossRef\]](#)
- [9] Zhang G, Liu H, Wang J, Wu B. Catalytic gasification characteristics of rice husk with calcined dolomite. *Energy* 2018;165:1173–1177. [\[CrossRef\]](#)
- [10] El-Shafay AS, Hegazi AA, Zeidan ESB, El-Emam SH, Okasha FM. Experimental and numerical study of sawdust air-gasification. *Alexandria Eng J* 2020;59:3665–3679. [\[CrossRef\]](#)
- [11] Angeline AA, Jayakumar J, Asirvatham LG, Wongwises S. Power generation from combusted "syngas" using hybrid thermoelectric generator and forecasting the performance with ANN technique. *J Therm Eng* 2018;4, Special Issue 8:2149–2168. [\[CrossRef\]](#)
- [12] Ghasemi A, Shayesteh AA, Doustgani A, Pazoki M. Thermodynamic assessment and optimization of a novel trigeneration energy system based on solar energy and MSW gasification using energy and exergy concept. *J Therm Eng* 2021;7:349–366. [\[CrossRef\]](#)
- [13] Du X, Li Y. Experimental comparison and optimization on granular bed filters with three types of filling schemes. *Appl Energy* 2019;253:113563. [\[CrossRef\]](#)
- [14] Tuomi S, Kurkela E, Simell P, Reinikainen M. Behaviour of tars on the filter in high temperature filtration of biomass-based gasification gas. *Fuel* 2015;139:220–231. [\[CrossRef\]](#)
- [15] Nakamura S, Kitano S, Yoshikawa K. Biomass gasification process with the tar removal technologies utilizing bio-oil scrubber and char bed. *Appl Energy* 2016;170:86–92. [\[CrossRef\]](#)
- [16] Milne TA, Evans RJ, Abatzoglou N. Biomass Gasifier "Tars": Their Nature, Formation, and Conversion. National Renewable Energy Laboratory; 1998:25357. [\[CrossRef\]](#)
- [17] Perpres 22 Tahun 2017. Peraturan Presiden Republik Indonesia Nomor 22 Tahun 2017 tentang Rencana Umum Energi Nasional.

- [18] Siswoputranto YS. *Prospek Percoklatan Dunia dan Kepentingan Indonesia*. Konvensi Coklat Nasional II. Medan, Indonesia; 1983.
- [19] Adjin-Tetteh M, Asiedu N, Doodoo-Arhin D, Karam A, Amaniampong PA. Thermochemical conversion and characterization of cocoa pod husks a potential agricultural waste from Ghana. *Ind Crops Prod* 2018;119:304-312. [\[CrossRef\]](#)
- [20] Sutar KB, Ravi MR, Kohli S. Design of a partially aerated naturally aspirated burner for producer gas. *Energy* 2016;116:773-785. [\[CrossRef\]](#)
- [21] Tryner J, Willson BD, Marchese AJ. The effects of fuel type and stove design on emissions and efficiency of natural-draft semi-gasifier biomass cookstoves. *Energy Sustain Dev* 2014;23:99-109. [\[CrossRef\]](#)
- [22] Obi OF, Ezeoha SL, Okorie IC. Energetic performance of a top-lit updraft (TLUD) cookstove. *Renewable Energy* 2019;99:730-737. [\[CrossRef\]](#)
- [23] Kaupp A, Goss JR. State of the art report for small scale (to 50 kW) gas producer - engine systems. Dept. of Agricultural Engineering University of California; 1981.
- [24] Guo F, Dong Y, Dong L, Guo C. Effect of design and operating parameters on the gasification process of biomass in a downdraft fixed bed: An experimental study. *Int J Hydrogen Energy* 2014;39:5625-5633. [\[CrossRef\]](#)
- [25] Wang Z, He T, Qin J, Wu J, Li J, Zi Z, Liu G, Wu J, Sun L. Gasification of biomass with oxygen-enriched air in a pilot scale two-stage gasifier. *Fuel* 2015;150:386-393. [\[CrossRef\]](#)
- [26] Jirakulsomchok A, Wongchang T, Prasartthong K. Experimental study of combustion of low-calorific producer gas from small scale biomass gasification within porous burner. *J Therm Eng* 2021;7:1344-1352. [\[CrossRef\]](#)
- [27] Chanphavong L, Zainal ZA. Characterization and challenge of development of producer gas fuel combustor: A review. *J Energy Inst* 2019;92:1577-1590.
- [28] Uchman W, Werle S. The use of low-calorific value gases. *Arch Civ Eng Environ* 2016;1:127-132. [\[CrossRef\]](#)
- [29] Chen Y, Shen G, Su S, Du W, Huangfu Y, Liu G, Xing B, Smith KR, Tao S, Wang X. Efficiencies and pollutant emissions from forced-draft biomass-pellet semi-gasifier stoves: Comparison of International and Chinese water boiling test protocols. *Energy Sustain Dev* 2016;32:22-30. [\[CrossRef\]](#)
- [30] Susastriawan AAP, Puwanto Y, Purnomo, Warisman A. Development of an air-stage downdraft and performance evaluation on feedstock of rice husk. *J Adv Res Fluid Mech Therm Sci* 2021;84:20-32. [\[CrossRef\]](#)
- [31] Basu P. *Biomass Gasification and Pyrolysis: Practical Design*. Elsevier Inc; 2010.
- [32] Parmigiani SP, Vitali F, Lezzi AM, Vaccari M. Design and performance assessment of a rice husk fueled stove for household cooking in a typical sub-Saharan setting. *Energy Sustain Dev* 2014;23:15-24. [\[CrossRef\]](#)