



Research Article

Comparative analysis and optimization of thermodynamic behavior of combined gas-steam power plant using grey-taguchi and artificial neural network

Komal MADAN^{1,*}, Omendra Kumar SINGH¹

¹Department of Mechanical and Automation Engineering, Indira Gandhi Delhi Technical University for Women, Delhi, 110006, India

ARTICLE INFO

Article history

Received: 20 April 2021

Accepted: 13 July 2021

Keywords:

Performance Enhancement; Grey-Taguchi Analysis; Artificial Neural Network; Optimal Conditions; Gas-Steam Power Cycle; Response Table

ABSTRACT

In the published studies, to the best of the authors' understanding, the grey Taguchi-based statistical technique has not been applied for the optimization of combined gas-steam power plants. In view of this, seven essential input parameters namely compressor inlet air temperature, pressure ratio, fuel temperature, volumetric flow rate of fuel, gas turbine maximum temperature, compressor efficiency, and turbine efficiency are chosen with the aim of determining the optimal combination of design variables that maximize the net power generation, thermal efficiency, exergetic efficiency, and minimize the specific fuel consumption. Also, the impact weight of each parameter on output indicators has been evaluated. While the Taguchi approach helps to create an orthogonal array of L27 (3^7), the ANOVA method determines the contribution of each input argument on the objective function. Unlike the Taguchi and ANOVA optimization methodology, the grey relational analysis is performed to transform the multi-objective function into a single objective by way of estimating its grey relational grade. The most favorable combination of input parameters is determined as $A_1B_1C_1D_1E_3F_3G_3$ and under this state, the optimum values of power generation, thermal efficiency, exergetic efficiency, and specific fuel consumption are found to be 259911 kW, 64.9 %, 66.27 %, and 0.1839 kg/kWh respectively. Moreover, the contribution ratio on the output characteristic of the combined cycle is found to be maximum for turbine efficiency (42.41 %) and minimum for fuel temperature (0.59 %). The effectiveness of the grey-Taguchi method is acknowledged and validated using an artificial neural network technique in MATLAB.

Cite this article as: Madan K, Singh O K. Comparative analysis and optimization of thermodynamic behavior of combined gas-steam power plant using grey-taguchi and artificial neural network. J Ther Eng 2023;9(1):45–60.

*Corresponding author.

*E-mail address: komal55_90@yahoo.co.in, oksingh61@rediffmail.com

This paper was recommended for publication in revised form by Regional editor Sandip Kale



INTRODUCTION

Presently, in developing countries, economic growth is most desirable, and energy is an essential requirement for economic growth. The increasing energy demand for economic growth is the major issue and challenge that draws appreciable attention towards energy conversion systems. Combined gas-steam-based power plants provide an efficient and effective technology for the conversion of energy resources with high fuel to power efficiency and low environmental emissions. Although, renewable energy sources cause no or low environmental emissions, they cannot generate so much electricity to cater for the complete energy demand. The latest data released by the International Energy Agency (IEA) [1] reveal that the contribution of all the renewables taken together to the total worldwide gross production of electricity is 25.6 % while the contribution of coal-based thermal power plants is 38.2 % and that of natural gas-based thermal power plants is 23.1 %. Therefore, the renewable energy-based power generation systems cannot completely replace the conventional thermal power plants although they are gaining increasing popularity. The natural gas-based thermal power plants basically use gas turbines to generate power. Combined cycle (CC) is a technology widely used these days for efficiency augmentation of the basic gas turbine plants. The most common CC is referred to as the Brayton-Rankine power generating cycle that utilizes heat energy of natural gas to produce power from two individual cycles. Many researchers conducted the performance test of combined cycle-based power plants theoretically and experimentally aiming to enhance the first and second law efficiency. The exergy method is a means to evaluate the energy quality, pinpoint the true location and magnitude of actual losses, and determine the maximal performance of a system using exergetic efficiency and exergy destruction rate [2,3]. Ersayin and Ozgener [4] examined the thermodynamic performance behavior of a CCP in terms of energy and exergy efficiencies by utilizing the operational statistics collected from the power station control unit. Singh and Kaushik [5] performed the exergy-based assessment of a 135 MW steam-based power plant situated at Delhi and assessed the effect of different operating variables on the performance parameters of the power plant through MATLAB simulation. The boiler of the plant was identified as the component of maximum exergy destruction. Singh [6] assessed thermodynamic irreversibility in various sections of a high-pressure boiler to find out the exact location of the maximum exergy destruction in it. In the analysis conducted by Singh and Kaushik [5], it was worked out that the low-temperature heat discharging out from the stack could be utilized to generate additional power. Singh [7,8] also investigated the possibility of utilizing low-grade waste exhaust heat from the cogeneration power plant of a sugar factory for running a cold storage and for generating power through the Kalina cycle.

Madan and Singh [9] utilized the flue gas heat discharging out from the stack to investigate the performance of a low-temperature operated organic Rankine cycle through energy and exergy-based analysis. Singh [10] integrated a waste heat-operated absorption refrigeration unit with the compressor of a 330 MW capacity natural gas-fired combined cycle power plant situated at Delhi to cool the incoming air into the two gas turbines. The outcomes indicated that the power generation of the plant increased by 9440 kW raising the energy efficiency by 1.193 % and exergetic efficiency by 1.133 %. In combined cycle power plants, the thermodynamic performance and the power generation are greatly affected by the gas turbine variables particularly, compressor pressure ratio, compressor inlet air temperature, isentropic efficiencies of compressor and turbine, fuel temperature, air/fuel ratio, exhaust temperature of gas turbine, pinch point temperature difference, inlet pressure and temperature of steam turbine, steam condition at condenser inlet and cooling water flow conditions, stack temperature. Although thermodynamic analysis is of great importance, the optimization of these power plants is mandatory for the continuous growth and development of the power generation sector. A broad spectrum of research has been carried out in literature to analyze and optimize the operation of power generation plants. Pan et al. [11] proposed a waste heat exchanger that includes a supercritical CO₂ cycle, an organic Rankine cycle, and a vapor absorption refrigeration cycle and optimized the integrated system in respect to its thermodynamic, economic, and environmental parameters. Many researchers performed multi-objective optimization of gas-steam cycle applying non-dominated sorting genetic algorithm (NSGA-II) optimization technique for augmenting thermodynamic performance and minimizing exergoeconomic cost, environmental impact, and heat transfer component cost [2,12–18]. Nadir et al. [19] optimized the thermodynamic configuration of the heat recovery steam generator for maximizing the net specific work output of the steam cycle and the net present worth as an objective function using the Particle Swarm Optimization technique. Even though many research articles have been published on the aforementioned optimization techniques, these methods are overly complex, non-linear, and time-intensive. Hence, simple, effective, linear, and less time-consuming methods are to be explored to maximize the performance curve of the studied system.

Grey relation analysis (GRA) is the most prominent and efficient statistical technique that evaluates multiple objective functions with a minimum number of trials [20,21]. Gul et al. [22] conducted an optimization study for a DI-CI diesel engine with different combinations of fuel consumption, speed, and load employing the grey-Taguchi method. Additionally, the ANOVA technique is applied to scrutinize the high impact parameter. The author in his another work [23] also conducted optimization studies on industrial gas turbines with different scales of input parameters using

the aforesaid technique. Bademlioglu et al. [24] selected nine parameters to perform optimization and evaluated the weight of each parameter influencing the performance behavior of the organic Rankine cycle using the grey-Taguchi statistical technique. Analogously, the application of the grey-Taguchi optimization methodology is widely applied in materials and industrial sectors [25–29]. The experimental findings and the simulated results obtained through the artificial neural network (ANN) technique with MATLAB software to conduct theoretical studies, e.g., [22] have been mostly found to match well with each other which verifies and validates the use of this technique. It is a technique that develops a highly complex non-linear correlation between input variables and output parameters [30,31].

In literature, the grey relational-Taguchi approach has been frequently applied to numerous industrial processes such as welding, turning, machining, cutting, etc. However, no research study is found regarding its application for optimizing a combined gas-steam power plant. Therefore, in the present work, this technique is chosen to conduct multi-objective optimization of a gas-steam-based power plant to maximize the net power generation, thermal efficiency and exergetic efficiency and minimize the specific fuel consumption simultaneously. In view of this, seven

essential input parameters namely the compressor inlet air temperature, pressure ratio, fuel temperature, volumetric flow rate of fuel, gas turbine maximum temperature, compressor efficiency, and turbine efficiency for three different levels are chosen using the grey relational statistical technique. The impact weight of each parameter on performance indicators is then calculated using the analysis of variance (ANOVA) method. Furthermore, the best and worst combinations of input parameters are defined as a result of grey relational analysis, and the results are validated using the artificial neural network approach.

PLANT DESCRIPTION AND ASSUMPTIONS

In this work, the operating data of a multi-shaft gas-steam-based power generation system shown in Fig. 1. are collected from the National Capital Power Station, NTPC, Dadri that generates 415MW of power. The performance specifications of the active CCPP are presented in Table 1. The composition of the fuel used is as follows: 94% CH₄, 4% C₂H₆, 1.2% C₃H₈, 0.8% C₄H₁₀ by volume. The system comprises of an air compressor, a fuel-heated chamber, a high-temperature gas turbine, a dual pressure exhaust heat recovery generator (EHRG), a power generating steam

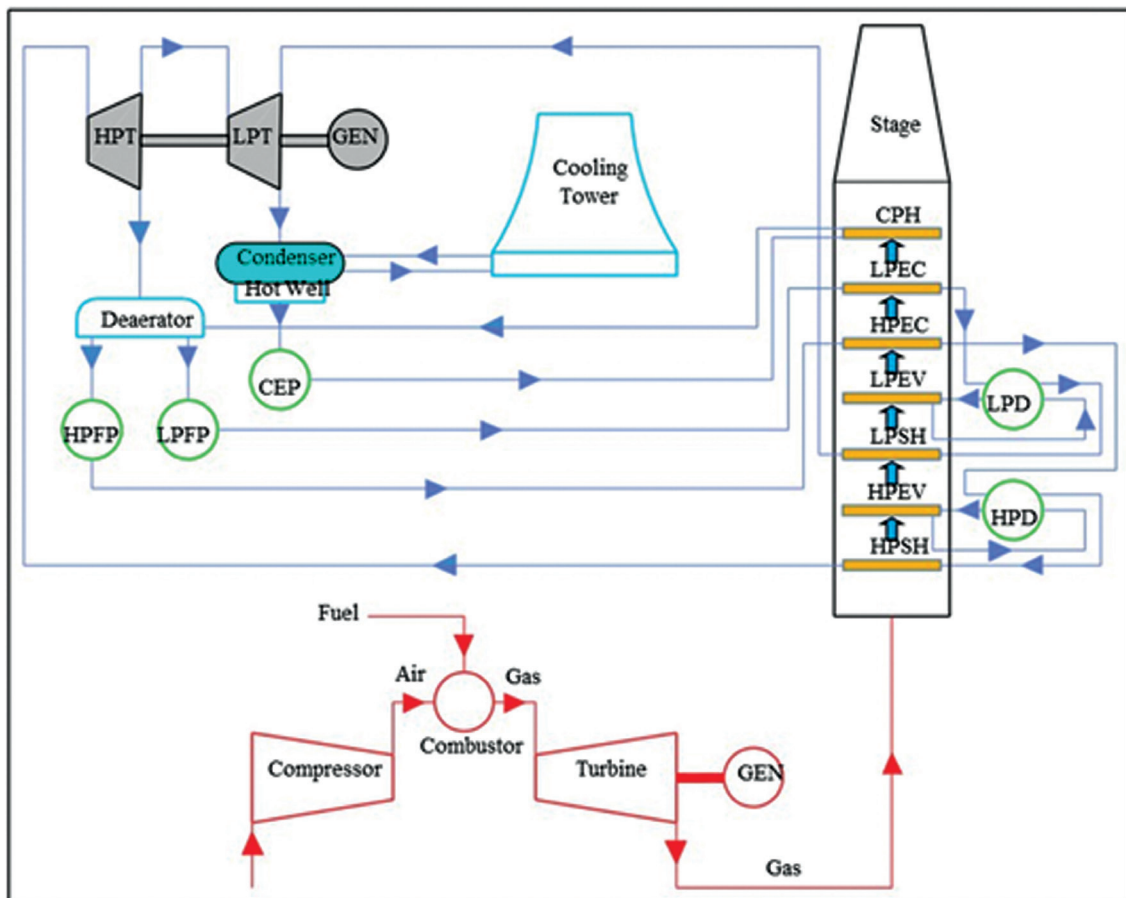

Figure 1. Simplified diagram of Gas-steam power generating plant.

Table 1. Performance specification of active CCGP

Input Data	Value	Units
Capacity	415	MW
Gas Turbine Power Output	131*2	MW
Steam Turbine Power Output	154	MW
Combined Cycle Efficiency	48.33	%
Maximum Temperature of Gas Turbine	1333.2	K
Compressor Pressure Ratio	10.2	-
Condensate Extraction Pump Power	270	kJ/s
Power Utilized by HP BFW Pump	1510	kJ/s
Power Utilized by LP BFW Pump	420	kJ/s

turbine (HP & LP), a water-cooled condenser, feedwater pumps and a deaerator. The high-pressure air and fuel combine in the chamber to produce high-temperature products that expand in the turbine to generate shaft work. Both gas turbine and air compressor are linked with common shaft. The high-temperature exhaust gases of the turbine are used by the recovery generator to deliver steam which is further used to drive steam turbine for power generation in combined cycle. The low-temperature combustion products are then disposed into the environment through the stack. The low-temperature wet steam departing from LP turbine is condensed in a water-cooled condenser and the condensate is pumped back to the boiler by the feedwater pump via a deaerator. The temperature of the low-grade heat discharging out from the stack is 100°C.

Following assumptions are used in the present work.

- Steady-state condition is assumed for energy and exergy flow.
- Potential and kinetic energies of the fluid at entry and exit of a plant component are neglected.
- All gases are assumed as ideal.
- The combustion of fuel takes place at constant pressure with no heat transfer to or from the surrounding.
- The working fluids for the topping and the bottoming cycles are the combustion gases and water/steam respectively.
- The expansion and the compression of fluid in the steam turbine and pumps are reversible adiabatic processes.
- Specific heat is a function of temperature only.
- Specific heat ratios for both air and combustion gases are taken as 1.4.

SYSTEM MODELLING

Mass, Energy, and Exergy Balance

Applying steady state energy equation to a control volume under given conditions, the mass, energy, and exergy balances can be defined as [5]

$$\sum \hat{m}_m = \sum \hat{m}_{ex} \quad (1)$$

$$\hat{E}_Q - \hat{E}_W = \sum \hat{m}_{ex} h_{ex} - \sum \hat{m}_m h_m \quad (2)$$

$$\sum \hat{m}_m \Psi_m + \hat{X}_Q = \sum \hat{m}_{ex} \Psi_{ex} + \hat{X}_W + \hat{X}_D \quad (3)$$

The rate of flow of exergy \hat{X}_Q due to heat transfer \hat{Q}_i at temperature T and that due to work transfer \hat{W} can be defined as

$$\hat{X}_Q = \left(1 - \frac{T_0}{T}\right) \hat{Q}_i \quad (4)$$

$$\hat{X}_W = \hat{W} \quad (5)$$

The total specific exergy Ψ_{tot} comprises physical, chemical, kinetic and potential exergies

$$\Psi_{tot} = (h - h_0) - T_0(s - s_0) + \Psi_{ch} + \frac{c^2}{2} + g_E Z_0 \quad (6)$$

Neglecting kinetic and potential exergies, it can be written as:

$$\Psi_{tot} = \Psi_{phy} + \Psi_{ch} \quad (7)$$

Physical Exergy

The maximum reversible work is gained in a physical process when a substance flows from its initial condition to the atmospheric condition involving thermal interaction only [32].

For water and steam,

$$\Psi_{ph} = (h - h_0) - T_0(s - s_0) \quad (8)$$

For the mixture of ideal gases,

$$\Psi_{ph} = (T - T_0) \sum_{i=1}^m x_i \hat{c}_p^{\Psi} + RT_0 \ln P/P_0 \quad (9)$$

where R stands as the characteristic gas constant, T_0 is the ambient temperature, x is the mole fraction, \hat{c}_p^{Ψ} is the specific molar heat capacity of exergy and P_0 is the ambient pressure.

For fuel,

The physical exergy of fuel at the environmental state (P_0, T_0) is zero. However, if the fuel flows into the combustion zone at some other condition, its physical exergy needs to be taken into account.

Chemical exergy

The maximum reversible work is gained when a substance flows from atmospheric condition to the dead state involving reaction and transfer of heat with the environment alone [32].

For Air,

Air mainly comprises of N₂, O₂, CO₂, H₂O and Ar which are in their elemental state. There is no shift in its chemical composition. Hence, there is no change in the chemical exergy [32] of air.

For a mixture of gases,

$$\Psi_{ch,m} = \sum_{i=1}^m x_i \Psi_{ch,i} + R_u T_0 \sum_{i=1}^m x_i \ln x_i \quad (10)$$

Combustion Process

The volumetric composition of natural gas considered is as follows:

Fuel component	CH ₄	C ₂ H ₆	C ₃ H ₈	C ₄ H ₁₀	N ₂
% by volume	94	4	1.2	0.78	0.02

The actual composition of air by volume is calculated at an ambient state (P₀=100900 Pa, T₀=307.15 K, RH= 36 %) on the day of data collection using the procedure described in [33]

Air component	O ₂	N ₂	H ₂ O(g)	CO ₂	Ar
% by volume	20.55	76.61	1.89	0.03081	0.92

The Air to fuel ratio by mass may be expressed as

$$(A/F)_{mass} = \frac{n_a \times M_a}{n_f \times M_f} \quad (11)$$

where n stands for number of moles, M is molecular mass, subscript a and f stands for air and fuel.

The rate of heat generation by fuel in kJ/kmol of fuel is given as [34]

$$\dot{E}_{cf} = - \left[\sum_P \dot{N}_P (\bar{h}_{f,P}^0 + \bar{h}_T - \bar{h}_{298}^0) - \sum_R \dot{N}_R (\bar{h}_{f,R}^0 + \bar{h}_T - \bar{h}_{298}^0) \right] \quad (12)$$

Following equations are taken from [10] to calculate the specific molar heat capacity $\hat{c}_{p,a}$ (kJ/kmol-K) for the fuel and other gases, where T is the temperature in K.

$$\hat{c}_{p,CH_4} = 19.25 + 5.213 \times 10^{-2} T + 1.197 \times 10^{-5} T^2 - 1.132 \times 10^{-8} T^3 \quad (13)$$

$$\hat{c}_{p,C_2H_6} = 5.409 + 17.81 \times 10^{-2} T + 6.938 \times 10^{-5} T^2 + 8.713 \times 10^{-8} T^3 \quad (14)$$

$$\hat{c}_{p,C_3H_8} = 4.224 + 30.63 \times 10^{-2} T + 15.86 \times 10^{-5} T^2 + 3.215 \times 10^{-8} T^3 \quad (15)$$

$$\hat{c}_{p,C_4H_{10}} = 9.487 + 33.13 \times 10^{-2} T - 1.108 \times 10^{-5} T^2 - 28.22 \times 10^{-8} T^3 \quad (16)$$

$$\hat{c}_{p,N_2} = 31.5 - 1.357 \times 10^{-2} T + 2.68 \times 10^{-5} T^2 - 1.168 \times 10^{-8} T^3 \quad (17)$$

$$\hat{c}_{p,O_2} = 28.11 - 0.000368 \times 10^{-2} T + 1.746 \times 10^{-5} T^2 - 1.065 \times 10^{-8} T^3 \quad (18)$$

$$\hat{c}_{p,Ar} = 20.8 \quad (19)$$

$$\hat{c}_{p,CO_2} = 19.8 + 7.344 \times 10^{-2} T - 5.602 \times 10^{-5} T^2 + 1.715 \times 10^{-8} T^3 \quad (20)$$

The sensible heat of enthalpy (kJ/s) can be defined as [10]

$$\sum_{i=1}^m \dot{n}_i \int_{T_0}^T \hat{c}_{p,i} dT \quad (21)$$

where, i = number of component, \dot{n}_i is the molar flow rate of the ith component (kmol/s) and $\hat{c}_{p,i}$ is the molar physical enthalpy (kJ/kmol) of the ith component.

Exit Temperatures of Air Compressor and Gas Turbine

The compressor exit temperature can be calculated by [10]

$$T_{g2} = T_{g1} + \frac{T_{g1}}{\eta_c} \left[\left(\frac{P_2}{P_1} \right)^{\frac{\gamma_a - 1}{\gamma_a}} - 1 \right] \quad (22)$$

The gas turbine exit temperature can be calculated by [10]

$$T_{g4} = T_{g3} - \eta_t T_{g3} \left[1 - \left(\frac{P_{g4}}{P_{g3}} \right)^{\frac{\gamma_g - 1}{\gamma_g}} \right] \quad (23)$$

where T_{g1} , T_{g3} , η_c and η_t are the compressor inlet air temperature, turbine inlet temperature, compressor efficiency, and turbine efficiency, respectively. The values of specific heat ratio for air and combustion gases are approximated to be equal and taken as 1.4.

Performance Parameters

The net power generation (kW) of the combined cycle can be expressed as

$$\widehat{W}_{cc} = (\widehat{W}_{t,gs} - \widehat{W}_{c,air}) + (\widehat{W}_{t,st} - (\widehat{W}_{CEP} - \widehat{W}_{HPP} - \widehat{W}_{LPP})_{p,water}) \quad (25)$$

The specific fuel consumption (SFC) can be expressed as

$$\phi_f = \frac{3600 m_f}{\widehat{W}_{net,GT}} \quad (26)$$

The overall energy efficiency of the combined cycle plant can be expressed as

$$\eta_{I,CC} = \frac{\widehat{W}_{cc}}{\widehat{E}_{cf}} \quad (27)$$

The overall exergy efficiency of the combined cycle plant can be expressed as

$$\eta_{II,CC} = \frac{\widehat{W}_{cc}}{\widehat{X}_f} \quad (28)$$

OPTIMIZATION METHODOLOGY

The methodology involves four steps:

- Develop a design of experiment (DOE) by selecting different levels and the input factor. For the present study, the number of levels opted are three and the input parameters are seven, hence, L_{27} (3^7) orthogonal array has been chosen for the design summary using the Taguchi method.
- In the second step, input experimental data and desired output are collected.
- Apply the optimization technique.
- In the end, output results are validated using the artificial neural network (ANN) approach

Taguchi Analysis

The Taguchi technique, first explained by Dr. Genichi Taguchi, is an effective statistical method extensively adopted in engineering systems to perform optimization using an orthogonal array table with a minimum count of experiments. This approach investigates the effect of considered design parameters on the different response variables using Signal-to-Noise (S/N) analysis.

Grey Relational analysis

This approach evaluates and categorizes the most effective input parameter that gives the best response to the variation. Table 2 describes the list of input parameters with different levels and the response variables. For this, the theoretical response data should be normalized with Larger is better, smaller is better, and nominal is better. The present study maximizes the net power generation, thermal efficiency and exergetic efficiency and minimizes the specific fuel consumption. The 'Larger is better' and the 'Smaller is better' are described in Eq (31) and (32) respectively.

Larger is better

$$y_i(f) = \frac{x_i(f) - \min x_i^n(f)}{\max x_i^n(f) - \min x_i^n(f)} \quad (31)$$

Smaller is better

$$y_i(f) = \frac{\max x_i^n(f) - x_i(f)}{\max x_i^n(f) - \min x_i^n(f)} \quad (32)$$

Furthermore, the grey relational coefficient (GRC) establishes the correlation between actual and comparable series, which is formulated as,

$$\Psi_i = \frac{\Delta_{\min} + \zeta \Delta_{\max}}{\Delta_i + \zeta \Delta_{\max}} \quad (33)$$

The grey relational grade (GRG) is then computed as the average of GRC values of all the parameters and can be expressed as

$$GRG = \frac{1}{n} \left(\sum_{y=1}^n \alpha_y \Psi_i \right) \quad (34)$$

Here $\sum_{y=1}^n \alpha_y = 1$

Analysis of Variance (ANOVA)

The significant contribution of each input parameter on the response variable can be determined by calculating the contribution ratio using the ANOVA approach. It has been proved in the literature that the higher the F-value of the input parameter, the more is the impact on the output variable.

$$\text{Contribution ratio (\%)} = \frac{(SS)_f}{(SS)_t} \quad (35)$$

where SS_i refers to sum of square of each input parameter and SS_t refers to the total sum of square of all the input parameters.

Table 2. Description of input parameters with different levels

Input Parameters	Code	No. of Levels			Response Variables
		1	2	3	
Compressor inlet air temperature (K)	A	307.15	305.15	303.15	Specific fuel consumption (SFC);
Pressure ratio (r_p)	B	10.2	11.5	13	Net Power generation;
Fuel temperature (K)	C	309.15	312.15	315.15	Thermal efficiency;
Fuel temperature (m^3/hr)	D	40444	40861	40664	Exergetic Efficiency;
Gas Turbine maximum temperature (K)	E	1327.2	1450	1550	
Compressor efficiency (η_{com}) (%)	F	88	90	92	
Turbine efficiency (η_{tur}) (%)	G	77	79	82	

The working procedure of ANN is equivalent to the human brain neuron network. Each neuron retrieves and saves the experimental observations during its training session. Then the neuron network is trained and simulated with the optimal group of variables of the grey Taguchi-based analysis. Neurons are associated with one another by their synaptic weights that function as per the nature of activation function such as logsig tan-sig or purelin to assess the needed outcome for a given input argument [35]. In MATLAB, the ‘nntool’ command builds, train and simulate an ANN that will help to validate the best possible collection of input factors obtained from the grey relational grade. If the expected and optimum experimental values are close to each other, then the

efficacy of the optimum combination can be validated and authenticated. This will provide optimum values of input parameters to the design engineer and the operators of the power plant.

RESULTS AND DISCUSSION

Under this segment, the GRA is implemented to optimize the multi-response variable by calculating its grey relational coefficient and converting them into a single response value by evaluating its grey relational grade, an illustration of which is explained in the above section. Thereafter, the contribution and impact of each parameter are analyzed using the ANOVA method. In the end, the

Table 3. Orthogonal Array-based experimental results of output response

Runs	Orthogonal Array Design							Output Response			
	A	B	C	D	E	F	G	W _{cc} (kW)	η_{th} (%)	η_{ex} (%)	SFC (kg/kWh)
1	1	1	1	1	1	1	1	212471	53.738	54.175	0.26990
2	1	1	1	1	2	2	2	245501	61.719	62.597	0.20368
3	1	1	1	1	3	3	3	259911	64.994	66.271	0.18398
4	1	2	2	2	1	1	1	221311	55.936	56.956	0.24845
5	1	2	2	2	2	2	2	239001	60.029	61.509	0.21414
6	1	2	2	2	3	3	3	254461	63.603	65.487	0.19108
7	1	3	3	3	1	1	1	210301	53.806	32.111	0.27202
8	1	3	3	3	2	2	2	229651	58.525	35.066	0.22770
9	1	3	3	3	3	3	3	246341	62.463	37.614	0.19964
10	2	1	2	3	1	2	3	249641	63.401	64.996	0.19677
11	2	1	2	3	2	3	1	240891	60.802	62.718	0.21001
12	2	1	2	3	3	1	2	246621	61.939	64.210	0.20114
13	2	2	3	1	1	2	3	240041	61.868	64.067	0.20825
14	2	2	3	1	2	3	1	232591	59.576	62.078	0.22099
15	2	2	3	1	3	1	2	238621	60.828	63.688	0.21056
16	2	3	1	2	1	2	3	234966	58.826	59.323	0.22325
17	2	3	1	2	2	3	1	228781	56.911	57.761	0.23496
18	2	3	1	2	3	1	2	235541	58.308	59.468	0.22222
19	3	1	3	2	1	3	2	241451	61.615	64.239	0.20812
20	3	1	3	2	2	1	3	252841	64.106	67.269	0.19142
21	3	1	3	2	3	2	1	239841	60.488	63.811	0.21072
22	3	2	1	3	1	3	2	235571	59.284	60.557	0.22109
23	3	2	1	3	2	1	3	248291	62.054	63.826	0.20063
24	3	2	1	3	3	2	1	237851	59.137	61.143	0.21712
25	3	3	2	1	1	3	2	225341	57.548	59.399	0.23725
26	3	3	2	1	2	1	3	238871	60.615	62.965	0.21217
27	3	3	2	1	3	2	1	229361	57.902	60.459	0.22920

performance parameters of the considered system are validated based on a neural network technique.

Formation of Output Response Using OA

Firstly, an orthogonal array (OA) of L27 (3^7) was designed to conduct experimentation in Minitab. There is a total of 27 experimental runs by taking seven input parameters namely, compressor inlet air temperature (A), pressure ratio (B.), inlet fuel temperature (C), the volumetric flow rate of fuel (D), inlet gas temperature (E), compressor isentropic efficiency (F), turbine isentropic efficiency (G) and 3 different levels to organize the output response namely, the net power generation (W_{cc}), energy efficiency (η_{en}), exergy efficiency (η_{ex}), and specific fuel consumption (SFC) as stated in Table 3.

From the experimentation results, it is noted that the decrease in compressor inlet air temperature decreases the power consumed by the compressor, increases the power developed by the turbine and hence, increases the net power output of the gas turbine cycle. The reason for the increase in power developed by the turbine with lower compressor inlet air temperature being that a decrease in air temperature increases the density of air and consequently, increases the mass flow rate [36]. The increase in net power output with the same fuel flow rate decreases the specific fuel consumption. On the other hand, compressor pressure ratio has an adverse effect on the net power output. When the compressor pressure ratio increases with an increase in turbine inlet temperature, the net power output decreases due to increase in the compressor work.

However, the overall thermal efficiency increases with a higher compression ratio [37,38]. Increasing the fuel temperature reduces the fuel consumption rate required for the same gas turbine inlet temperature and thereby reduces the power output of the cycle. But, the overall thermal efficiency increases with an increase in the temperature of the fuel. The isentropic efficiency describes the efficacy of the turbine and compressor and affects the overall performance of the system [39].

Grey Taguchi Analysis

Normalization of output response

The comparative analysis for different response variables cannot be made as they are assigned with different dimensions. So, it is important to alter them in dimensionless quantity and hence normalization for output response data was performed for the objective function as mentioned in Table 4. The value of normalized data lies between 0 and 1 and values closer to 1 suggest better performance characteristics [40]

Computation of Grey Relational Coefficient (GRC) and Grey Relational Grade (GRG)

Subsequently, a quality loss function (QLF) or deviation of response variables from actual series is evaluated which is a measure of the variation of actual from comparable series. The smaller the value of QLF, the closer is the ideal approach condition with the minimum loss [41]. The GRC can be determined using the QLF and develops correlation among actual and comparable series. The transformation of the multi-objective function into a single response variable

Table 4. Normalization of output response

Runs	Normalization of Output response				Runs	Normalization of Output response			
	Larger is better		Smaller is better			Larger is better		Smaller is better	
	W_{cc}	η_{th}	η_{ex}	SFC		W_{cc}	η_{th}	η_{ex}	SFC
1	0.04374	0.00000	0.62756	0.02400	15	0.57085	0.62985	0.89813	0.69808
2	0.70953	0.70906	0.86711	0.77628	16	0.49718	0.45201	0.77397	0.55396
3	1.00000	1.00000	0.97162	1.00000	17	0.37251	0.28184	0.72956	0.42092
4	0.22193	0.19525	0.70666	0.26775	18	0.50877	0.40598	0.77810	0.56566
5	0.57851	0.55892	0.83615	0.65744	19	0.62790	0.69980	0.91381	0.72580
6	0.89014	0.87638	0.94932	0.91937	20	0.85749	0.92112	1.00000	0.91549
7	0.00000	0.00601	0.00000	0.00000	21	0.59544	0.59967	0.90162	0.69629
8	0.39004	0.42524	0.08404	0.50344	22	0.50937	0.49270	0.80907	0.57843
9	0.72647	0.77512	0.15652	0.82214	23	0.76577	0.73881	0.90208	0.81093
10	0.79299	0.85846	0.93535	0.85479	24	0.55533	0.47968	0.82574	0.62353
11	0.61661	0.62755	0.87055	0.70436	25	0.30317	0.33847	0.77614	0.39491
12	0.73211	0.72855	0.91298	0.80506	26	0.57589	0.61094	0.87758	0.67982
13	0.59948	0.72226	0.90891	0.72438	27	0.38420	0.36990	0.80628	0.48635
14	0.44931	0.51865	0.85235	0.57958					

Table 5. Estimation of parameters of Grey relational-Taguchi method

Runs	Quality Loss function (Δ)				Gray Relational Coefficient ($\zeta = 0.5$)				Grade (GRG)	Rank
	W_{CC}	η_{th}	η_{th}	SFC	W_{CC}	η_{th}	η_{th}	SFC		
1	0.95626	1.00000	0.37243	0.97600	0.34335	0.33333	0.57311	0.33875	0.39714	26
2	0.29047	0.29094	0.13289	0.22372	0.63254	0.63216	0.79003	0.69088	0.68640	7
3	0.00000	0.00000	0.02838	0.00000	1.00000	1.00000	0.94629	1.00000	0.98657	1
4	0.77807	0.80475	0.29334	0.73225	0.39122	0.38322	0.63025	0.40576	0.45261	24
5	0.42149	0.44108	0.16385	0.34256	0.54260	0.53130	0.75319	0.59343	0.60513	15
6	0.10986	0.12363	0.05068	0.08064	0.81986	0.80176	0.90797	0.86113	0.00000	3
7	1.00000	0.99399	1.00000	1.00000	0.33333	0.33467	0.33333	0.33333	0.33367	27
8	0.60996	0.57476	0.91596	0.49656	0.45047	0.46522	0.35312	0.50173	0.44263	25
9	0.27353	0.22488	0.84348	0.17787	0.64638	0.68977	0.37217	0.73761	0.61148	14
10	0.20702	0.14154	0.06465	0.14521	0.70720	0.77938	0.88550	0.77495	0.78675	4
11	0.38339	0.37245	0.12945	0.29564	0.56600	0.57310	0.79434	0.62842	0.64047	12
12	0.26789	0.27146	0.08702	0.19494	0.65114	0.64813	0.85176	0.71949	0.71763	6
13	0.40052	0.27774	0.09109	0.27562	0.55523	0.64289	0.84589	0.64465	0.67216	9
14	0.55070	0.48135	0.14765	0.42042	0.47588	0.50950	0.77203	0.54323	0.57516	17
15	0.42915	0.37015	0.10187	0.30192	0.53813	0.57461	0.83074	0.62351	0.64175	10
16	0.50282	0.54799	0.22603	0.44604	0.49859	0.47710	0.68868	0.52852	0.54822	19
17	0.62749	0.71816	0.27044	0.57908	0.44346	0.41046	0.64898	0.46336	0.49156	23
18	0.49123	0.59402	0.22190	0.43434	0.50442	0.45703	0.69262	0.53514	0.54730	20
19	0.37210	0.30020	0.08619	0.27420	0.57333	0.62484	0.85296	0.64583	0.67424	8
20	0.14251	0.07888	0.00000	0.08451	0.77820	0.86373	1.00000	0.85542	0.87434	2
21	0.40456	0.40033	0.09838	0.30371	0.55276	0.55535	0.83560	0.62211	0.64145	11
22	0.49063	0.50730	0.19093	0.42157	0.50473	0.49638	0.72367	0.54255	0.56683	18
23	0.23423	0.26119	0.09792	0.18907	0.68099	0.65686	0.83623	0.72562	0.72493	5
24	0.44467	0.52032	0.17426	0.37647	0.52929	0.49004	0.74156	0.57047	0.58284	16
25	0.69684	0.66153	0.22386	0.60509	0.41777	0.43047	0.69074	0.45245	0.49786	22
26	0.42411	0.38907	0.12242	0.32019	0.54106	0.56239	0.80332	0.60962	0.62910	13
27	0.61580	0.63010	0.19372	0.51365	0.44811	0.44244	0.72076	0.49327	0.52614	21

is done with the help of gray relational grade (GRG) [42]. With reference to OA and GRC values, the GRG and rank for different experiments can be evaluated using Eq. (34) and demonstrated in Table 5. Higher count of GRG implies that input conditions and output responses are close to an optimal solution.

Optimal combinations of parameters

The most favorable association of input parameters is analyzed from GRG values for each experiment. The higher value of grade ensures closer to optimality. The graphical representation of GRG for different experiment runs is presented in Fig. 2. and indicates the impact and influence of each parameter on output results. Fig. 2. reveals that Case 3 and Case 7 have the highest and lowest value of GRG among 27 runs. Taking into account all combinations, the optimum input conditions for the most favorable performance of a

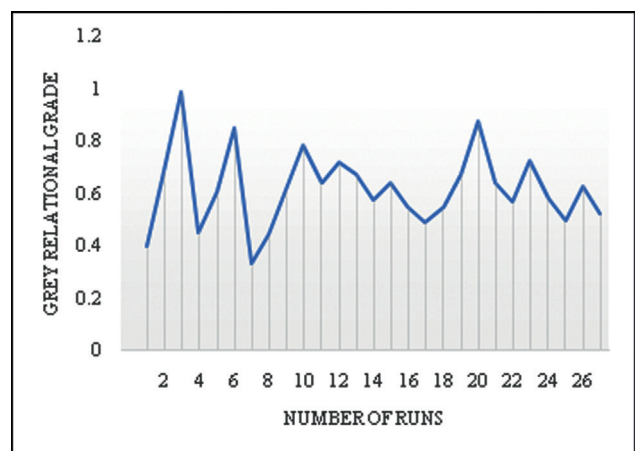

Figure 2. Variation of grey relational grade for different number of runs.

combined gas-steam plant are determined as compressor inlet air temperature = 307.15 K, pressure ratio = 10.2, fuel temperature = 309.15 K, volumetric flow rate of fuel = 40444 m³/hr, gas turbine maximum temperature = 1550 K, compressor efficiency = 92 %, turbine efficiency = 82 %. Under this condition (A₁B₁C₁D₁E₃F₃G₃), the optimum power generated, thermal efficiency, exergetic efficiency, and specific fuel consumption comes out to be 259911 kW, 64.9 %, 66.27 %, and 0.1839 kg/kWh respectively. Furthermore, the condition A₁B₃C₃D₃E₁F₁G₁ minimizes the system performance

with conditions as follow, compressor inlet air temperature = 307.15 K, pressure ratio = 13, fuel temperature = 315.15 K, volumetric flow rate of fuel = 40664 m³/hr, gas turbine maximum temperature = 1327.15 K, compressor efficiency = 88 %, turbine efficiency = 77 % respectively. The net power generated, thermal efficiency, exergetic efficiency, and specific fuel consumption at this state are 259911 kW, 64.9 %, 66.27 %, 0.1839 kg/kWh and 210301 kW, 53.8 %, 32.1 %, 0.2720 kg/kWh, respectively.

Response table is developed for different factors using GRG to pinpoint the impact of all parameters on the response variable as displayed in Table 6. The arrangement of precedence of input parameters for the optimum performance of the system is G> B>E>F>A>D>C. The maximum and minimum response of parameters for different levels are shown in Fig. 3.

Table 6. Grey relational grade-based response table

Level	A	B	C	D	E	F	G
1	-4.997	-3.188	-4.494	-4.353	-5.512	-4.933	-5.934
2	-4.174	-4.134	-4.131	-4.195	-4.171	-4.399	-4.566
3	-4.058	-5.908	-4.604	-4.682	-3.547	-3.898	-2.730
Delta	0.939	2.720	0.473	0.487	1.965	1.035	3.205
Rank	5	2	7	6	3	4	1

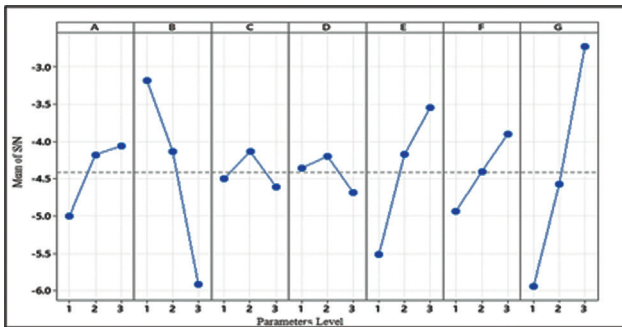

Figure 3. Multiple response characteristic for different input parameters level.

Analysis of Variance (ANOVA)

Applying the ANOVA method, the significant contribution of each parameter is examined and analyzed based on multiple objective functions as displayed in Table 7 [43,44]. It can be seen from the findings that the impact of turbine efficiency on the performance characteristic is maximum with a contribution ratio of 42.41 %, followed by pressure ratio (31.69 %), gas turbine maximum temperature (13.99 %), compressor efficiency (3.43 %), compressor inlet air temperature (1.33 %), the volumetric flow rate of fuel (0.81 %) and fuel temperature (0.59 %) which are in accord with the response table using GRG. The literature [45,46] reveals that if the probability (P-value) of any parameter is less than 0.05, the parameter is significant. In the results, the P-value for turbine efficiency and pressure ratio is 0.000, hence contributes maximum.

It is clearly understandable from the ANOVA findings that turbine efficiency is the most important parameter to be considered for the performance of the CC. The effect of turbine efficiency on system performance has also been

Table 7. Contribution of each parameter on output variables using grey relational grade

Parameters	DF	Adj SS	Adj MS	F-Value	P-Value	Contribution Ratio (%)
Compressor inlet air temperature	2	0.00746	0.00373	1.400	0.284	1.33415
Pressure ratio	2	0.17716	0.08858	33.250	0.000	31.69150
Fuel Temperature	2	0.00332	0.00166	0.620	0.553	0.59355
Volumetric flow rate of fuel	2	0.00455	0.00227	0.850	0.450	0.81341
Gas turbine inlet temperature	2	0.07823	0.03912	14.690	0.001	13.99515
Compressor efficiency	2	0.01922	0.00961	3.610	0.059	3.43805
Turbine efficiency	2	0.23711	0.11856	44.510	0.000	42.41621
Error	12	0.03196	0.00266			
Total	26	0.55901				

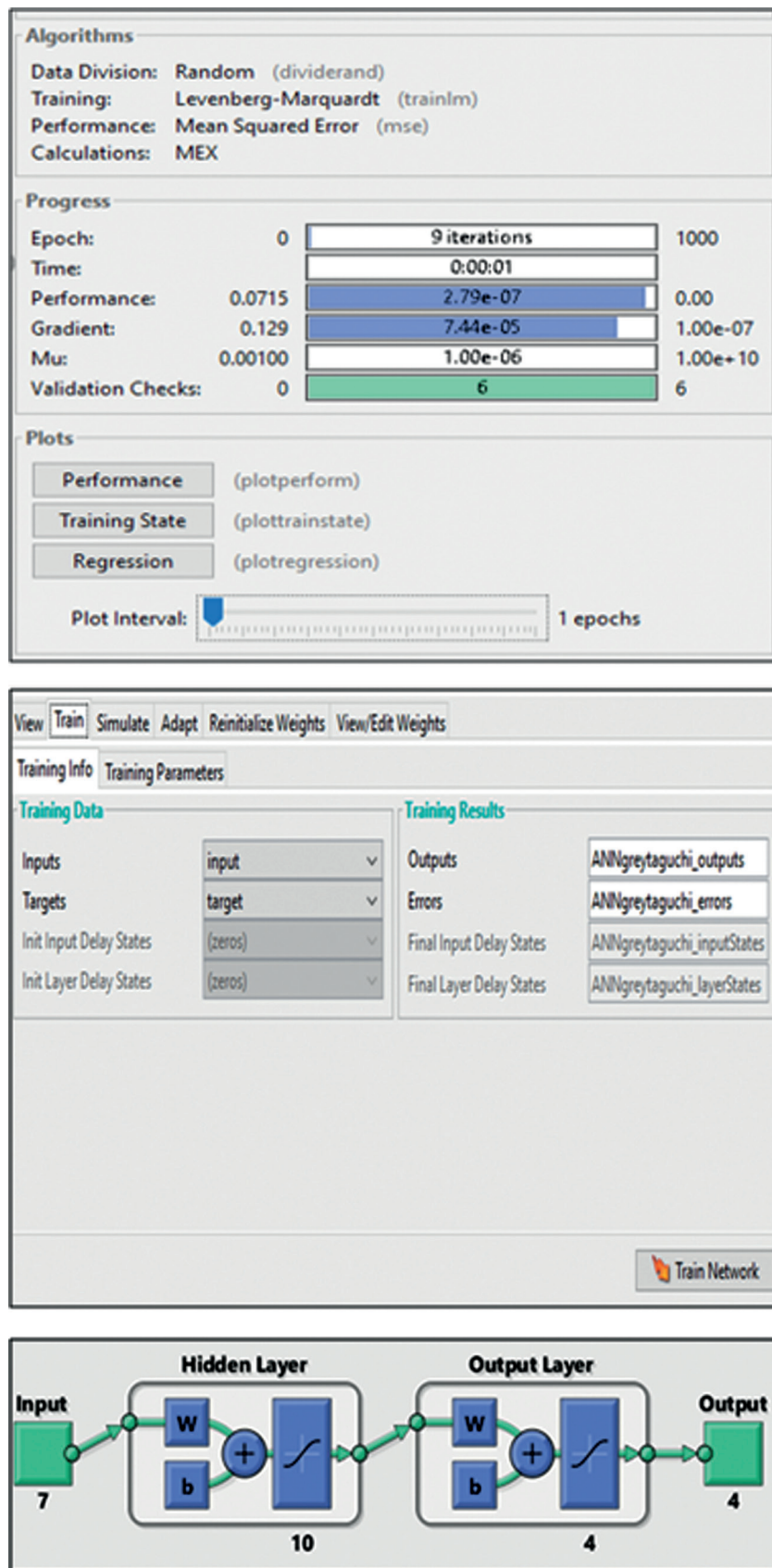

Figure 4. Modelling and Training using Artificial Neural Network Technique.

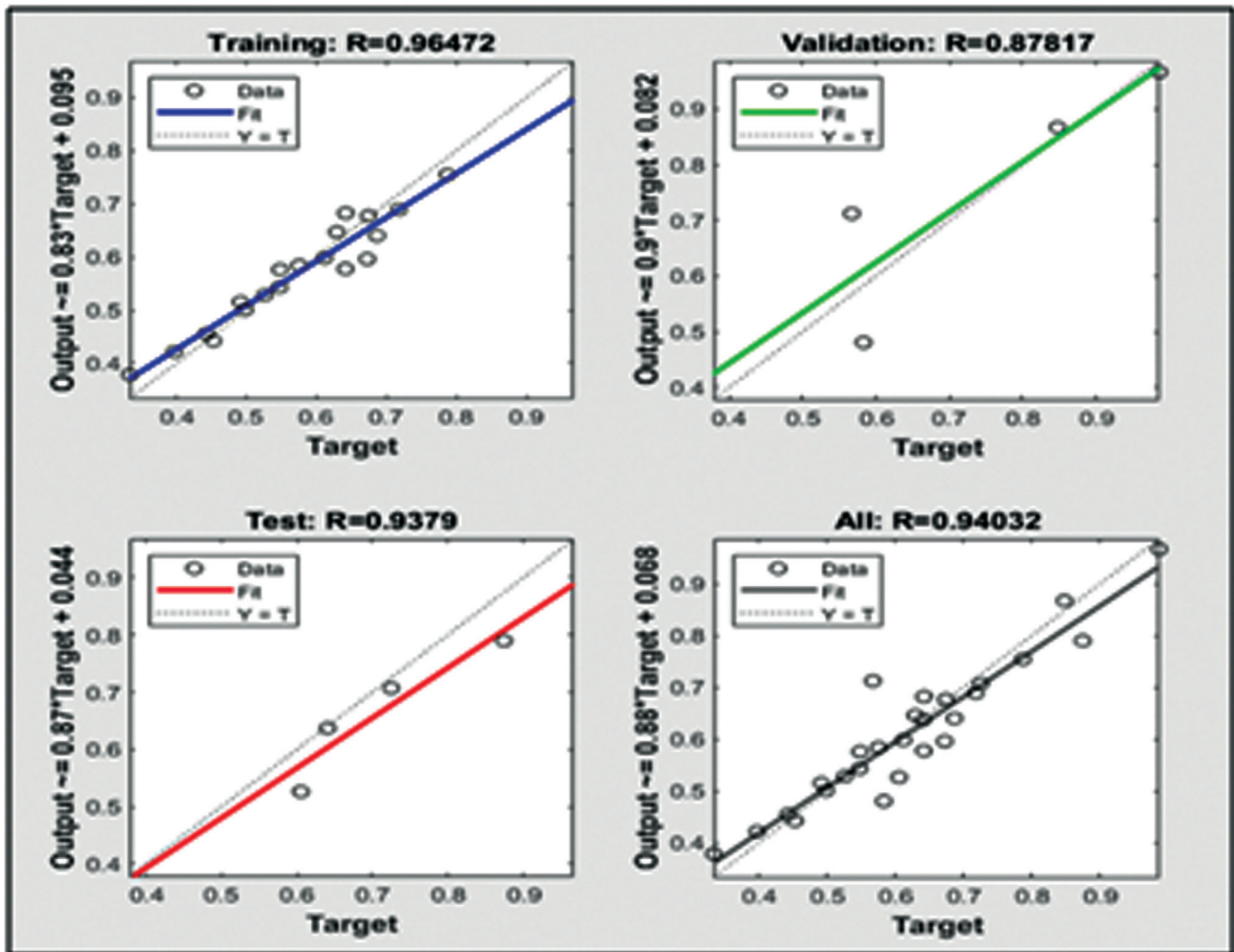

Figure 5. Regression plot for Neural Network.

studied by Siddiqui and Dincer [47], and Ibrahim and Rahman [48] and reveals that higher efficiency of the turbine increases the power and thermodynamic efficiency of the overall system. It is also obvious from the results that fuel parameters are less important while considering the multiple responses of the system.

Validation of Grey-Taguchi analysis results using Artificial neural network (ANN)

Finally, the neural network simulating methodology is opted to verify and validate the optimal response obtained by the Grey-Taguchi method. Numerous researchers [31,49–51] use this technique for the validation of output results of engineering applications. With the aid of the 'nntool' command and importing input and target parameters from Table 2, the ANN model is created, trained, and simulated using the feed-forward backprop technique with the number of neurons layers to be 3 namely, input layers

(7 neurons), hidden layer (10 neurons) and output layer (4 neurons) as shown in Fig. 4. The selection of neurons for the hidden layer is undertaken using the trial-and-error method. In the hidden layer, the number of neurons can be changed in the course of training until TANSIG (tangent sigmoid) reduces the mean square error to 0.0527. The coefficient of Regression (R) measures the degree of deviation of predicted and actual values as depicted in Fig. 5 and reveals that the data of predicted values are closely related to the grey Taguchi results. Furthermore, it turns out from Fig. 6 that the optimal output response for the ANN criterion is obtained at epoch 3. Also, Fig 7. compares the output result obtained from grey Taguchi and ANN method with GRG as target parameter and indicates that the results obtained from both the methods show optimality at Run 3. This validates the potential and effectiveness of the grey Taguchi analysis and neural network procedure.

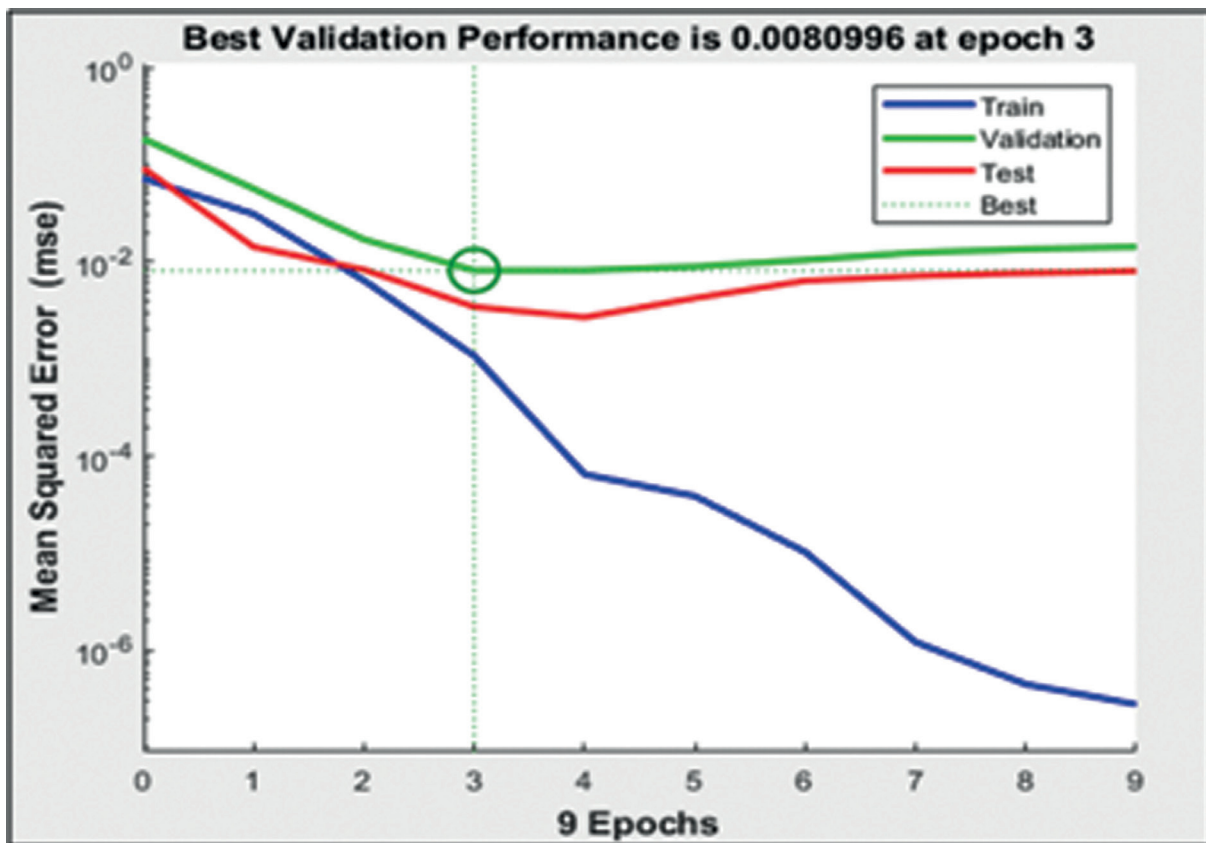

Figure 6. Performance plot for optimal conditions.

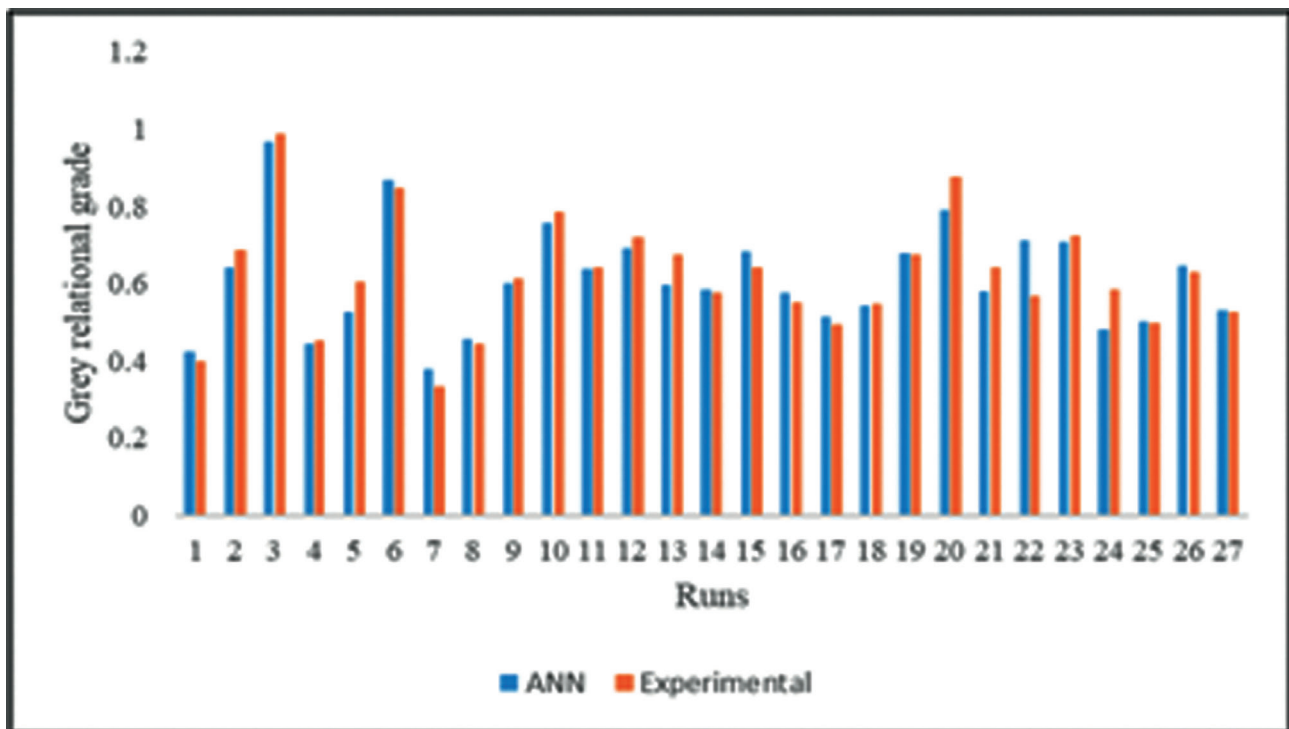

Figure 7. Comparison of output results based on Grey relational grade.

CONCLUSIONS

This research work is aimed to investigate the optimal combination of input parameters and their contribution to achieve the multi-objective optimization of a combined gas-steam-based power plant using Taguchi-based grey relational analysis. In this investigation, compressor inlet air temperature, pressure ratio, fuel temperature, volumetric flow rate of fuel, gas turbine maximum temperature, compressor efficiency, and turbine efficiency have been considered. The impact of aforesaid parameters on net power generation, thermal efficiency, exergetic efficiency, and specific fuel consumption was examined. The major findings of the work are as follows.

- The optimum input conditions for the most favorable performance of the combined gas-steam plant under study are obtained as: compressor inlet air temperature = 307.15 K, pressure ratio = 10.2, fuel inlet temperature = 309.15 K, volumetric flow rate of fuel = 40444 m³/hr, gas turbine maximum temperature = 1550 K, compressor efficiency = 92 %, turbine efficiency = 82 %.
- Under the maximum (A₁B₁C₁D₁E₃F₃G₃) and minimum (A₁B₃C₃D₃E₁F₁G₁) conditions, the net power generated, thermal efficiency, exergetic efficiency, and specific fuel consumption come out to be 259911 kW, 64.9%, 66.27%, 0.1839 kg/kWh and 210301 kW, 53.8 %, 32.1 %, 0.2720 kg/kWh respectively.
- ANOVA analysis reveals that the impact of turbine efficiency on the performance characteristic is maximum with a contribution ratio of 42.41 %, followed by pressure ratio (31.69 %), gas turbine (13.99 %), compressor efficiency (3.43 %), ambient temperature (1.33 %), the volumetric flow rate of fuel (0.81 %) and the fuel temperature (0.59 %). These results are in accordance with the response table obtained using grey relation grade.
- The optimal output response values obtained from grey Taguchi analysis are close to the predicted values of artificial neural network and reveals that both methods have high potential and efficacy to yield optimal results.

ACKNOWLEDGMENTS

The present work was performed using the facilities provided in the premises of Mechanical and Automation Engineering Department, Indira Gandhi Delhi Technical University for Women, Delhi, India where the first and the corresponding author of this paper is receiving financial assistance under the JRF/SRF financial assistance scheme. The author is highly thankful to the University authorities for the same.

AUTHORSHIP CONTRIBUTIONS

Authors equally contributed to this work.

DATA AVAILABILITY STATEMENT

The authors confirm that the data that supports the findings of this study are available within the article. Raw data that support the finding of this study are available from the corresponding author, upon reasonable request.

CONFLICT OF INTEREST

The author declared no potential conflicts of interest with respect to the research, authorship, and/or publication of this article.

ETHICS

There are no ethical issues with the publication of this manuscript.

REFERENCES

- [1] International Energy Agency. World energy balances: Overview. Available at: <https://www.iea.org/reports/world-energy-balances-overview> Accessed on June 24, 2021.
- [2] Ahmadi P, Dincer I, Rosen MA. Exergy, exergoeconomic and environmental analyses and evolutionary algorithm based multi-objective optimization of combined cycle power plants. *Energy* 2011;36:5886–5898. [CrossRef]
- [3] Mahian O, Mirzaie MR, Kasaeian A, Mousavi SH. Exergy analysis in combined heat and power systems: A review. *Energy Convers Manag* 2020;226:113467. [CrossRef]
- [4] Ersayin E, Ozgener L. Performance analysis of combined cycle power plants: A case study. *Renew Sustain Energy Rev* 2015;43:832–842. [CrossRef]
- [5] Singh OK, Kaushik SC. Energy and exergy analysis and optimization of Kalina cycle coupled with a coal fired steam power plant. *Appl Therm Eng* 2013;51:787–800. [CrossRef]
- [6] Singh OK. Assessment of thermodynamic irreversibility in different zones of a heavy fuel oil fired high pressure boiler. *J Therm Anal Calorim* 2016;123:829–840. [CrossRef]
- [7] Singh OK. Exergy analysis of a grid-connected bagasse-based cogeneration plant of sugar factory and exhaust heat utilization for running a cold storage. *Renew Energy* 2019;143:149–163. [CrossRef]
- [8] Singh OK. Application of Kalina cycle for augmenting performance of bagasse-fired cogeneration plant of sugar industry. *Fuel* 2020;267:117176. [CrossRef]
- [9] Madan K, Singh OK. Performance augmentation of low-temperature sub-critical organic rankine cycle using first and second law-based analysis. In: Muzammil M, Chandra A, Kankar PK, Kumar

- H, editors. Proceedings of ITME: International Conference on Innovative Technologies in Mechanical Engineering; 2021 Oct 18-19; Uttar Pradesh, India: Springer; 2019. pp. 229–237. [\[CrossRef\]](#)
- [10] Singh OK. Performance enhancement of combined cycle power plant using inlet air cooling by exhaust heat operated ammonia-water absorption refrigeration system. *Appl Energy* 2016;180:867–879. [\[CrossRef\]](#)
- [11] Pan M, Lu F, Zhu Y, Li H, Yin J, Liao Y, et al. 4E analysis and multiple objective optimizations of a cascade waste heat recovery system for waste-to-energy plant. *Energy Convers Manag* 2021;230:113765. [\[CrossRef\]](#)
- [12] Javadi MA, Ghomashi H. Thermodynamics analysis and optimization of Abadan combined cycle power plant. *Indian J Sci Technol* 2016;9:1–12. [\[CrossRef\]](#)
- [13] Gu H, Cui X, Zhu H, Si F, Kong Y. Multi-objective optimization analysis on gas-steam combined cycle system with exergy theory. *J Clean Prod* 2021;278:123939. [\[CrossRef\]](#)
- [14] Mohtaram S, Sun HG, Lin J, Chen W, Sun Y. Multi-objective evolutionary optimization & 4E analysis of a bulky combined cycle power plant by CO₂/CO/NO_x reduction and cost controlling targets. *Renew Sustain Energy Rev* 2020;128:109898. [\[CrossRef\]](#)
- [15] Shamoushaki M, Ehyaei MA. Optimization of gas turbine power plant by evolutionary algorithm; considering exergy, economic and environmental aspects. *J Therm Eng* 2020;6:180–200. [\[CrossRef\]](#)
- [16] Ganjehkaviri A, Jaafar MNM, Ahmadi P, Barzegaravval H. Modelling and optimization of combined cycle power plant based on exergoeconomic and environmental analyses. *Appl Therm Eng* 2014;67:566–578. [\[CrossRef\]](#)
- [17] Rezaie A, Tsatsaronis G, Hellwig U. Thermal design and optimization of a heat recovery steam generator in a combined-cycle power plant by applying a genetic algorithm. *Energy* 2019;168:346–357. [\[CrossRef\]](#)
- [18] Selleri T, Najafi B, Rinaldi F, Colombo G. Mathematical modeling and multi-objective optimization of a mini-channel heat exchanger via genetic algorithm. *J Therm Sci Eng Appl* 2013;5:031013. [\[CrossRef\]](#)
- [19] Nadir M, Ghenaiet A, Carcasci C. Thermo-economic optimization of heat recovery steam generator for a range of gas turbine exhaust temperatures. *Appl Therm Eng* 2016;106:811–826. [\[CrossRef\]](#)
- [20] Acir A, Canli ME, Ata I, Çakiroglu R. Parametric optimization of energy and exergy analyses of a novel solar air heater with grey relational analysis. *Appl Therm Eng* 2017;122:330–338. [\[CrossRef\]](#)
- [21] Mia M, Rifat A, Tanvir MF, Gupta MK, Hossain MJ, Goswami A. Multi-objective optimization of chip-tool interaction parameters using Grey-Taguchi method in MQL-assisted turning. *Measurement* 2018;129:156–166. [\[CrossRef\]](#)
- [22] Gul M, Shah AN, Aziz U, Husnain N, Abbas M, Kousar T, et al. Grey-Taguchi and ANN based optimization of a better performing low-emission diesel engine fueled with biodiesel. *Energy Sources A: Recovery Util Environ Eff* 2022;44:1019–1032. [\[CrossRef\]](#)
- [23] Gul M, Kalam MA, Mujtaba MA, Alam S, Bashir MN, Javed I, et al. Multi-objective-optimization of process parameters of industrial-gas-turbine fueled with natural gas by using Grey-Taguchi and ANN methods for better performance. *Energy Rep* 2020;6:2394–2402. [\[CrossRef\]](#)
- [24] Bademlioglu AH, Canbolat AS, Kaynakli O. Multi-objective optimization of parameters affecting Organic Rankine Cycle performance characteristics with Taguchi-Grey Relational Analysis. *Renew Sustain Energy Rev* 2020;117:109483. [\[CrossRef\]](#)
- [25] Vijayan D, Rao VS. Friction stir welding of age-hardenable aluminum alloys: A parametric approach using RSM based GRA coupled with PCA. *J Inst Eng Ser C* 2014;95:127–141. [\[CrossRef\]](#)
- [26] Mustapha AN, Zhang Y, Zhang Z, Ding Y, Yuan Q, Li Y. Taguchi and ANOVA analysis for the optimization of the microencapsulation of a volatile phase change material. *J Mater Res Technol* 2021;11:667–680. [\[CrossRef\]](#)
- [27] Unnikrishna Pillai J, Sanghrajka I, Shunmugavel M, Muthuramalingam T, Goldberg M, Littlefair G. Optimisation of multiple response characteristics on end milling of aluminium alloy using Taguchi-Grey relational approach. *Measurement* 2018;124:291–298. [\[CrossRef\]](#)
- [28] Tsai MJ, Li CH. The use of grey relational analysis to determine laser cutting parameters for QFN packages with multiple performance characteristics. *Opt Laser Technol* 2009;41:914–921. [\[CrossRef\]](#)
- [29] Thangaraj M, Annamalai R, Moiduddin K, Alkindi M, Ramalingam S, Alghamdi O. Enhancing the surface quality of micro titanium alloy specimen in WEDM process by adopting TGRA-based optimization. *Materials* 2020;13:1440. [\[CrossRef\]](#)
- [30] Ghobadian B, Rahimi H, Nikbakht AM, Najafi G, Yusaf TF. Diesel engine performance and exhaust emission analysis using waste cooking biodiesel fuel with an artificial neural network. *Renew Energy* 2009;34:976–982. [\[CrossRef\]](#)
- [31] Kannan GR, Balasubramanian KR, Anand R. Artificial neural network approach to study the effect of injection pressure and timing on diesel engine performance fueled with biodiesel. *Int J Automot Technol* 2013;14:507–519. [\[CrossRef\]](#)
- [32] Kotas TJ. *The Exergy Method Of Thermal Plant Analysis*. Amsterdam: Elsevier; 2013.

- [33] Singh OK. Combustion simulation and emission control in natural gas fuelled combustor of gas turbine. *J Therm Anal Calorim* 2016;125:949–957. [\[CrossRef\]](#)
- [34] Cengel Y, Boles M. *Thermodynamics: An Engineering Approach*. 8th edition. New York: McGraw-Hill Education; 2015.
- [35] Fausett LV, Elwasif W. Predicting performance from test scores using backpropagation and counterpropagation. *Proceedings of 1994 IEEE International Conference on Neural Networks (ICNN'94)*; 1994 Jun 28-Jul 2; Orlando, USA: IEEE; 1994. pp. 3398–3402.
- [36] Sanaye S, Fardad A, Mostakhdemi M. Thermoeconomic optimization of an ice thermal storage system for gas turbine inlet cooling. *Energy* 2011;36:1057–1067. [\[CrossRef\]](#)
- [37] Ibrahim TK, Rahman MM. Effects of isentropic efficiencies on the performance of combined cycle power plants. *Int J Automot Mech* 2015;12:2914–2928. [\[CrossRef\]](#)
- [38] Mohtaram S, Chen W, Zargar T, Lin J. Energy-exergy analysis of compressor pressure ratio effects on thermodynamic performance of ammonia water combined cycle. *Energy Convers Manag* 2017;134:77–87. [\[CrossRef\]](#)
- [39] Živić M, Galović A, Virag Z. Detailed analysis of the effect of the turbine and compressor isentropic efficiency on the thermal and exergy efficiency of a Brayton cycle. *Therm Sci* 2014;18:843–852. [\[CrossRef\]](#)
- [40] Kopac J, Krajnik P. Robust design of flank milling parameters based on grey-Taguchi method. *J Mater Process Technol* 2007;191:400–403. [\[CrossRef\]](#)
- [41] Gul M, Shah AN, Jamal Y, Masood I. Multi-variable optimization of diesel engine fuelled with biodiesel using grey-Taguchi method. *J Braz Soc Mech Sci Eng* 2016;38:621–632. [\[CrossRef\]](#)
- [42] Jung JH, Kwon WT. Optimization of EDM process for multiple performance characteristics using Taguchi method and Grey relational analysis. *J Mech Sci Technol* 2010;24:1083–1090. [\[CrossRef\]](#)
- [43] Li CH, Tsai MJ. Multi-objective optimization of laser cutting for flash memory modules with special shapes using grey relational analysis. *Opt Laser Technol* 2009;41:634–642. [\[CrossRef\]](#)
- [44] Zębala W, Kowalczyk R. Estimating the effect of cutting data on surface roughness and cutting force during WC-Co turning with PCD tool using Taguchi design and ANOVA analysis. *Int J Adv Manuf Technol* 2015;77:2241–2256. [\[CrossRef\]](#)
- [45] Kolakoti A, Mosa PR, Kotaru TG, Mahapatro M. Optimization of biodiesel production from waste cooking sunflower oil by taguchi and ann techniques. *J Therm Eng* 2020;6:712–723. [\[CrossRef\]](#)
- [46] Dhawane SH, Kumar T, Halder G. Biodiesel synthesis from Hevea brasiliensis oil employing carbon supported heterogeneous catalyst: Optimization by Taguchi method. *Renew Energy* 2016;89:506–514. [\[CrossRef\]](#)
- [47] Siddiqui O, Dincer I. Energy and Exergy Analyses of a Geothermal-Based Integrated System for Trigeneration. In: Dincer I, Colpan CO, Kizilkan O, editors. *Exergetic, energetic and environmental dimensions*. 1st ed. Massachusetts: Academic Press; 2018. pp. 213–231. [\[CrossRef\]](#)
- [48] Ibrahim TK, Rahman MM. Effect of compression ratio on performance of combined cycle gas turbine. *Int J Energy Eng* 2012;2:9–14. [\[CrossRef\]](#)
- [49] Makhfi S, Habak M, Velasco R, Haddouche K, Vantomme P. Prediction of cutting forces using ANNs approach in hard turning of AISI 52100 steel. In: Menary G, editor. *The 14th International Esaform Conference On Material Forming: ESAFORM 2011*; 2011 Apr 27-29; Belfast, UK: AIP Publishing; 2011. pp. 669–674. [\[CrossRef\]](#)
- [50] Wijayasekara D, Manic M, Sabharwall P, Utgikar V. Optimal artificial neural network architecture selection for performance prediction of compact heat exchanger with the EBaLM-OTR technique. *Nucl Eng Des* 2011;241:2549–2557. [\[CrossRef\]](#)
- [51] Lazzaretto A, Toffolo A. Analytical and neural network models for gas turbine design and off-design simulation. *Int J Thermodyn* 2001;4:173–182.