

EXERGETIC OPTIMIZATION OF PHOSPHORIC ACID FACTORY POWER PLANT

T. Khir^{1,*}, F. Hafdhi², A. Ben Yahia³, A. Ben Braim²

ABSTRACT

An Energetic and Exergetic Analysis is conducted on a Steam Turbine Power Plant of an existing Phosphoric Acid Factory. The heat recovery systems used in different parts of the plant are also considered in the analysis. Mass, thermal and exergy balances are established on the main components of the factory. A numerical code is established using EES software to perform the calculations required for the thermal and exergy plant analysis. The effects of the key operating parameters such as steam pressure and temperature, mass flow rate as well as seawater temperature, on the cycle performances are investigated.

The minimum Exergy Destruction Rates are obtained for the condensers and deaerators followed by the blowers and turbines. The Steam Turbine Generator STGI presents the maximum irreversibility rates of about 4.1 MW. For the explored ranges of HP steam pressure, the energy efficiencies of steam turbine generators STGI and STGII increase of about 1.37 % and 8.8 % respectively. While the exergy efficiencies increase of about 2.46 for STGI and 6.8 % for STGII. In the same way optimum HP steam flow rate values, leading to the maximum exergy efficiencies are defined.

Keywords: *Condenser, Energy Efficiency, Exergy Efficiency, Phosphoric Acid Plant, Steam Turbine Generator*

INTRODUCTION

The Tunisian production of Phosphoric Acid is among the five important ones in the world. Indeed the phosphate constitutes an important factor for the country economy balance. The annual production of Phosphoric Acid is about 500 000 tonnes. Despite the economic importance of the phosphate industry, the total annual cost of the energy production is very substantial. To overcome this problem, the Tunisian Chemical Group (TCG) established programs in the purpose to improve the quality of production and increase the performance of the different plants. Among these programs, a study is developed on the performance optimization of thermal power plant operated in phosphoric acid factory. This study is conducted by the Applied Thermodynamic Research Unit in collaboration with TCG.

Furthermore, several investigations were conducted on energy and exergy optimization of chemical industrial factory power plants. S. Adibhatla et al. [1] carried out an energetic and exergetic analysis of 660 MWe thermal power plant at different load conditions and according to two operating modes: under constant pressure and under pure sliding pressure. The performance criteria are defined. Therefore, the exergy destruction rates are identified for each component. In the developed analysis, it has been shown that the boiler has the highest source of exergy losses followed by the turbine. Moreover, considering the two indicated operating modes, the results reveal a significant decrease in exergy destruction rate for the turbine and boiler feed pump when operating in sliding pressure mode.

CJ Koroneos et al. [2] conducted an exergy analysis of a 300 MW lignite thermoelectric power plant. A comparative study is established between the actual plant and three proposed combined heat and power systems. Equal amount of fuel is used for the three considered systems working according to Rankine cogeneration cycle. Obtain results show that the cogeneration system design leads to an improvement at about 8.5% in energy production compared to other proposed configurations.

A Thermodynamic and exergoeconomic analysis of thermal power plant is performed by A. Bolatturk et al. [3]. Using EES software the inlet and outlet thermodynamic properties of each component are determined. That permits to define energy and exergy efficiencies. Obtained results show that the main amounts of exergy losses are located in the boiler, in the turbine, in the condenser, in the heater and in the pump groups. While the

This paper was recommended for publication in revised form by Regional Editor Jaap Hoffman

¹*Department of Mechanical Engineering, National Engineering School of Gabes, Tunisia*

²*Department of Chemical Engineering, National Engineering School of Gabes, Tunisia*

³*Tunisian Chemical Group, Gabes, Tunisia*

**E-mail address: taherkhir@yahoo.fr*

Manuscript Received 22 January 2016, Accepted 1 July 2016

highest amount of exergy loss costs are observed in the boiler, followed by the turbines and the condenser. Authors suggest that exergy and economic analysis of the thermal plants in project stage may be helpful to undertake future investigations and can minimize significantly the energy consumption of thermal systems.

A. Atmaca. et al. [4] are developed a thermodynamic and exergoeconomic analysis of a cement plant placed in Gaziantep, Turkey. The considered plant has highest energy consumption and it is classified among the most industrial source of the CO₂ emissions. In order to evaluate the performance of the factory, the authors are established mass, thermal and exergy balances for each component considering variation ranges of operating parameters. A set of performance criteria are defined in the aim to conduct this analysis.

A general methodology for exergy balance in chemical and thermal process integrated in the ProSimPlus code was performed by A. Ghannadzadeh et al [5]. In the purpose to fully automate the exergy analysis, the authors established an exergy balance for the whole system using only one software. The adopted procedure permits not only to identify the exergy destruction source but it also to reduce the exergy losses.

M. N. Khan et al. [6] developed a thermodynamic optimization for a four configurations of a combined steam and gas cycle with heat recovery steam generator. A parametric study is carried out in the purpose to determine the effect of the pressure ratio and the inlet turbine temperature (TIT) on the cycle performance. The results reveal that an increase in TIT leads to an increase in net output power of about 32.1% with 1500 K and 19.3 % with 2000 K.

An advanced energetic and exergetic analysis for a part of rubber factory has been conducted by G. D. Vucovic et al. [7]. The main role of the considered part is the production of steam, compressed air as well as cooling and hot water. Thermal and exergy balances are established for each components of the plant in order to evaluate their performances. The exergy destructions are located for the different streams and their magnitude are determined. That permits to evaluate the system exergy efficiency. Furthermore authors are divided the exergy destructions rates into avoidable and unavoidable parts. The obtain results showed that reducing the avoidable exergy destruction rates lead to an improvement in the exergy efficiency.

In order to determine the energy and exergy efficiency uncertainties of thermal power plant A. Ege et al. [8] carried out an energy and exergy investigation for lignite thermal power plant at various load conditions. For this reason, authors established a black box method by applying a sensitivity analysis in accordance with the operating parameter variations. For the different power outputs, the results reveal a range varied between 1.82–1.98% for energy efficiency uncertainty and 1.32–1.43% for exergy efficiency of the power plant. Moreover, the Lower Heating Value (LHV) determination represents the highest source of uncertainties in energy and exergy efficiency.

J. Taillon et al. [9] illustrate a graphical representation of energy efficiencies related to Combined Heat and Power (CHP) and condensing plants. Basing exclusively on the energy efficiencies does not permit a suitable comparison between the different energy system performances. Therefore authors conducted an exergy analysis on 24 existing industrial factories and established two news graphs: the first one illustrates the electrical, thermal and total exergy efficiencies of condensing and CHP power plants. The second graph splits the thermal and exergy efficiency in two components: thermal losses and useful heat output quality.

A thermoeconomic optimization of a steam turbine power plant with a capacity of 450 MW is carried out by L. Anetor et al. [10]. Exergy and economic balances are established for each component. All calculations are performed using the sequential quadratic programming (SQP) algorithm. The main results show that the outlet steam of the boiler has the minimum exergy cost while the highest one is assigned for the condenser. Moreover, authors found that the pump inefficiencies cause an increase of the stream costs. Furthermore, the optimization of the different plant equipment leads to an enhancement of the capital and operational cost while only the capital cost was improved for the condenser optimization.

O. K. Singh et al. [11] conducted a numerical study on Kalina cycle coupled with steam power plant stimulated by coal in order to valorize the exhaust gases at low temperature for electricity production. A model is developed in the purpose to optimize the cycle performances according to the main operating parameters. An optimum ammonia fraction value leading to the maximum cycle efficiency is obtained for a given turbine inlet pressure. Therefore it has been demonstrated that the maximum cycle efficiency increases significantly with the turbine inlet pressure. For turbine inlet pressure of 4000 kPa and an ammonia fraction of 0.8, an improvement of 0.277% and 0.255% in the overall energy and exergy efficiency respectively.

In order to define proper operating and maintenance decisions, T.K. Ray et al. [12] developed an exergy analysis of a 500 MW steam power plant. The study is conducted considering design and off-design conditions

for various values of superheat and reheats sprays. The obtain results constitute help tools for exergoeconomic and maintenance optimization of similar power plants.

P. Regulagadda et al. [13] performed a thermodynamic analysis of a subcritical boiler-turbine generator for a 32 MW coal-fired power plant. Energy and exergy equation governing the cycle are established. A parametric study is conducted for a range of operating variables. That permits to define the optimum parameters leading to the best plant performances. The boiler and turbine engender the maximum exergy destruction rates in the power plant. The identification of the exergy losses in the different cycles has permitted to develop an environmental impact and sustainability analysis.

A comparison between nine coal-fired power plants in Turkey is conducted by H. H. Erdem et al. [14]. For each plant a calculation model is proposed and the mass, energy and exergy balances are established. That permits to determine the energy and exergy efficiency as well the exergy destruction rate of each component. A comparison is then accomplished between the considered power plants. The obtained results may constitute helpful tools for further investigations in the field of energetic and exergetic industrial power plant analysis.

F. Molés et al. [15] conducted a thermodynamic analysis of a combined organic Rankine cycle and vapor compression cycle system using two different fluids with low Global Warming Potentials GWP for each cycle. System performances are determined for ranges of operating conditions variations. Results show that the combined cycle COP varied between 0.30 and 1.10 while the computed electrical COP is varied between 15 and 110. Furthermore, for vapor compression system the selection of working fluid does not affect significantly the thermal and electrical efficiencies. Whereas for ORC the working fluid has an important influence especially on the electrical efficiency.

F. Hajabdollahi et al. [16] established a soft computing based multi-objective optimization of steam cycle power plant using Non-dominated Sorting Genetic Algorithm (NSGA-II) and Artificial Neural Network (ANN). The main cycle parameter at the inlet and outlet of the different components are considered for the optimization design. The maximization of the thermal efficiency and the minimization of the total cost rate are taken as objective function is chosen in the purpose to optimize the running conditions of the power plant. Obtain results reveal an increase of the thermal efficiency of about 3.76% and a decrease of the total cost rate of about 3.84%.

A. Keçebaş [17] carried out a thermal, exergo-economic and environmental investigation of an existing geothermal district heating systems installed in Afyon, Turkey. Based on data collected from the plant, authors conduct an analysis in order to evaluate the heating system performance, the energy and exergy efficiencies, the specific exergy index as well as the exergy destruction. Obtained results show an energy and exergy efficiencies of the overall heating system of about 34.86% and 48.78%, respectively. Authors suggest that the main exergy destruction rates are due to fluid reinjection, losses in heat exchangers and pipe lines, natural direct discharge and the pump losses. Others advantages of the system are pointed out by authors such as positive effects on the environment and low investment costs.

A. S. Karakurt et al. [18] carried out an analysis of steam turbine power plant performance under different load and off design conditions. The effect of operating parameters on the steam turbine efficiency is also studied. Obtained results showed that the design inlet high pressure turbine remains constant with variations of load conditions. Whereas, the outlet pressure of different steam turbine technologies vary according to the load. In other hand, the generated power is decreased with reducing the steam mass flow rate despite the increasing of specific work.

R. Arora et al. [19] performed a study on the performance analysis of Brayton heat engine. The results show that the engine designed at maximum efficient power criterion is more efficient compared with those designed at maximum power and maximum power density conditions. The effect of the operating parameters on the engine performances are analyzed.

N. Doseva et al. [20] conducted an energy and exergy analysis of cogeneration system with biogas engines.

An exergetic and exergoeconomic analysis for solar thermal power plant is developed by A. M. Elsafi [21]. Two steam power cycles are studied, with and without reheating system. Exergy and economic balances are established for each component of the cycle. The obtained results show that the main sources of exergy destruction are the solar field followed by the condenser, the LP turbine and the HP turbine. From thermo-economic point of view and based on the total cost rate, the most expensive component is the solar field followed by the LP turbine, HP turbine and the condenser. Authors analyzed the effect of steam reheat degree at

the inlet of the LP turbine on the system performances. They observe that an increase in reheat degree of about 100 K leads to an increase of 9.1% in vapor fraction at the turbine outlet and a decrease of 1.5% in energetic and exergetic efficiencies. Unfortunately an increase in electricity cost of about 2% is obtained.

S. Peng et al. [22] carried out an exergy investigation on solar hybrid coal fired power plant of 330 MW. Solar system is used to heating feed water at temperature below 300 °C in the purpose to substitute the steam extraction from steam turbine. That permits to improve the net electrical power generated by the steam turbine. A thermal and economic comparison study is also established between solar-only and solar-hybrid coal-fired power plants. According to the analysis results lower irreversibility rates are achieved in the solar feed water heater and the steam turbine. An enhancement in exergy efficiency and solar energy conversion are obtained. Also the hybrid coal-fired power plant seems to be economically beneficial than the solar-only thermal power plant.

M. H. K. Manesh et al. [23] developed an exergoeconomic and exergoenvironmental analysis on the coupling of a gas fired steam power plant with a total site utility system. The main purpose of the study is to analyze the incorporation of a steam power plant as an energy supply source for a site utility system. An appropriate method is used to optimize the integration of a steam power plant and a site utility effect on the whole plant performances. The obtain results show that this proposed design is a beneficial way leading to an enhancement of energy and exergy efficiencies as well as good environmental impacts. Moreover this integration leads to a decrease of the total annualized cost of the whole system compared with initial base design.

In this study, energy and exergy analysis is conducted on a Steam Turbine Power Plant installed in a Phosphoric Acid factory in the purpose to define the optimum operating conditions. The main components of the plant are presented. Mass, thermal and exergy balances are established. In order to perform all calculations required for the exergetic analysis, a code is developed using EES software. The power plant performances are analyzed taking into consideration variation ranges of the main operating parameters.

SYSTEM DESCRIPTION

The diagram of the Phosphoric Acid Thermal Power Plant is presented in Figure 1. This plant is installed in the industrial area of the Tunisian Chemical Group (TCG) located in Gabes (South East - Tunisia). The main product of this factory is the Phosphoric Acid with about 1500 t as daily production. The thermal power plant of the indicated factory is mainly constituted by two steam turbine cycles STGI and STGII used to provide about 14 MW as total net electrical power required for the different units. The High Pressure steam (HP) mass flow rate, consumed by STGI and STGII is generated by an Evaporator Boiler Pre-superheater Superheater group (EBPS) at about 40 bars and 410 °C. The steam turbine cycle STGI is with extraction and condensation, while the second one STGII is with back pressure turbine.

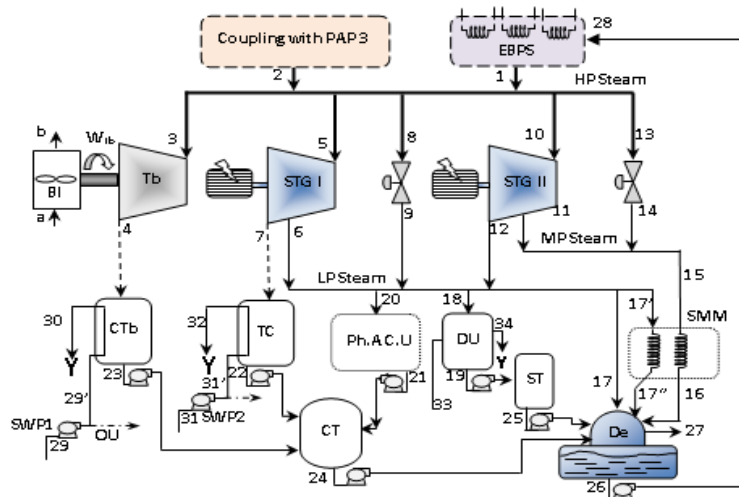

Bl: Blower, CT: Condensate Tank, CTb: Turbo-blower Condenser, De: Deaerator, DU: Distillation Unit, EBPS: Evaporator_Boiler_Pre-superheater_Superheater, Ph.A. C.U.: Phosphoric Acid Concentration Unit, SMM: Sulfur Melting and Maintenance, ST: Storage Tank, STGI/II: Steam Turbine Generator I/II, Tb: Turbine, SWP: Seawater Pump, TC: Turbine Condenser

Figure 1. Diagram of phosphoric acid thermal power plant

The Medium Pressure steam (MP) at 12 bars and 280 °C and Low Pressure steam (LP) at 6 bars and 230°C, used to supply the other different units, are obtained by the expansion of HP stream through appropriate devices (8-9) and (13-14). For the steam turbine STGI the input steam mass flow rate (point 5) is expanded to reach the extraction level at Low pressure (point 6). The remained steam flow rate (called condensation rate) is extended through the last stage of the turbine to reach the condensation pressure level at point 7. The condensation occurs in the seawater turbine condenser (TC). The tank (CT) is used for condensate storage. In the second steam turbine cycle STGII, HP steam expands from point 10 to reach the medium pressure MP at the extraction level (point 11). The remained stream is expanded to low pressure LP (point 12). The Turbo-blower Tb is used to provide compressed air for the sulfur combustion process in a sulfuric unit not presented on the diagram. The steam from the Turbo blower is condensed in CTb and then transferred to the storage tank CT. The MP and LP streams are used in the units (SMM, Ph. A CU, DU, TC, CTb and De). The condensate issued from all the indicated units is transferred to the tank (CT) in order to feed two deaerators (De) working under the same conditions. A water treatment is performed inside the deaerators before boilers supply. Appropriate sensors are used to measure the operating parameters such as: temperatures, pressures and mass flow rates. The variation ranges of these parameters are given in Table 1.

Table 1. Operating parameter ranges

OPERATING PARAMETERS	Temperature Ranges (°C)	Pressure Ranges (bar)	Mass Flow Rate
HP steam	386-395	39-41	179 (t/h)
MP steam	190	12	18 (t/h)
LP steam	165	5.7	135 (t/h)
Seawater	15-35	Input: 1 Output: 4	45 – 90 m ³ /h for each pump
Seawater salinity	0.039 kg/kg		
Air Relative Humidity	0.45 – 0.8		

ENERGY AND EXERGY BALANCES

In order to perform the energy and exergy analysis the following assumptions are considered [24]:

- All process are assumed as steady-state and steady flow
- The kinetic , potential and chemical exergy are neglected
- The dead state was considered as P₀=1.013 bar and T₀= 293.15 K
- No chemical reaction is occurred in the different processes

For an open system and taking into account the indicated assumptions, the energetic and exergetic balances can be expressed as flow:

$$\dot{Q} - \dot{W} = \sum \dot{m}_{out} h_{out} - \sum \dot{m}_{in} h_{in} \quad (1)$$

$$\dot{X}_{heat} - \dot{W} = \sum \dot{m}_{out} \varepsilon_{out} - \sum \dot{m}_{in} \varepsilon_{in} + \dot{E}_D \quad (2)$$

where the exergy transferred by heat is given by:

$$\dot{X}_{heat} = \sum \left(1 - \frac{T_0}{T}\right) \dot{Q} \quad (3)$$

and the specific exergy is showed as:

$$\varepsilon_i = (h_i - h_0) - T_0(s_i - s_0) \quad (4)$$

According to the stream numbering indicated in Figure 1, the energy and exergy balances for each component are given as follows:

STG I

$$\dot{W}_{STGI} = \dot{m}_5(h_5 - h_6) + (\dot{m}_5 - \dot{m}_6)(h_6 - h_7) \quad (5)$$

$$\dot{E}_{D,STGI} = \dot{m}_5(\varepsilon_5 - \varepsilon_6) + (\dot{m}_5 - \dot{m}_6)(\varepsilon_6 - \varepsilon_7) - \dot{W}_{STGI} \quad (6)$$

$$\eta_{e,STGI} = \frac{\dot{W}_{STGI}}{\dot{m}_5 h_5 - \dot{m}_6 h_6 - \dot{m}_7 h_7} \quad (7)$$

$$\eta_{ex,STGI} = \frac{\dot{W}_{STGI}}{\dot{m}_5(\varepsilon_5 - \varepsilon_6) + (\dot{m}_5 - \dot{m}_6)(\varepsilon_6 - \varepsilon_7)} \quad (8)$$

STG II

$$\dot{W}_{STGII} = \dot{m}_{10}(h_{10} - h_{11}) + (\dot{m}_{10} - \dot{m}_{11})(h_{11} - h_{12}) \quad (9)$$

$$\dot{E}_{D,STGII} = \dot{m}_{10}(\varepsilon_{10} - \varepsilon_{11}) + (\dot{m}_{10} - \dot{m}_{11})(\varepsilon_{11} - \varepsilon_{12}) - \dot{W}_{STGII} \quad (10)$$

$$\eta_{e,STGII} = \frac{\dot{W}_{STGII}}{\dot{m}_{10} h_{10} - \dot{m}_{11} h_{11} - \dot{m}_{12} h_{12}} \quad (11)$$

$$\eta_{ex,STGII} = \frac{\dot{W}_{STGII}}{\dot{m}_{10}(\varepsilon_{10} - \varepsilon_{11}) + (\dot{m}_{10} - \dot{m}_{11})(\varepsilon_{11} - \varepsilon_{12})} \quad (12)$$

Turbine Condenser (TC)

$$0 = \dot{m}_7(h_7 - h_{22}) + \dot{m}_{31'}(h_{31'} - h_{32}) - \text{Energy loss} \quad (13)$$

$$\dot{E}_{D,TC} = \dot{m}_7(\varepsilon_7 - \varepsilon_{22}) + \dot{m}_{31'}(\varepsilon_{31'} - \varepsilon_{32}) \quad (14)$$

$$\eta_{e,TC} = \frac{\dot{m}_{31'}(h_{32} - h_{31'})}{\dot{m}_7(h_7 - h_{22})} \quad (15)$$

$$\eta_{ex,TC} = \frac{\dot{m}_{31'}(\varepsilon_{32} - \varepsilon_{31'})}{\dot{m}_7(\varepsilon_7 - \varepsilon_{22})} \quad (16)$$

Condenser of Turbo-blower

$$0 = \dot{m}_4(h_4 - h_{23}) + \dot{m}_{29'}(h_{29'} - h_{30}) - \text{Energy loss} \quad (17)$$

$$\dot{E}_{D,CTb} = \dot{m}_4(\varepsilon_4 - \varepsilon_{23}) + \dot{m}_{29'}(\varepsilon_{29'} - \varepsilon_{30}) \quad (18)$$

$$\eta_{e,CTb} = \frac{\dot{m}_{29'}(h_{30} - h_{29'})}{\dot{m}_4(h_4 - h_{23})} \quad (19)$$

$$\eta_{ex,CTb} = \frac{\dot{m}_{29'}(\varepsilon_{30} - \varepsilon_{29'})}{\dot{m}_4(\varepsilon_4 - \varepsilon_{23})} \quad (20)$$

Turbo-blower of Steam turbine

$$\dot{W}_{Tb} = \dot{m}_3(h_3 - h_4) \quad (21)$$

$$\dot{E}_{D,Tb} = \dot{m}_3(\varepsilon_3 - \varepsilon_4) - \dot{W}_{Tb} \quad (22)$$

$$\eta_{e,Tb} = \frac{\dot{W}_{Tb}}{\dot{m}_3(h_3 - h_4)} \quad (23)$$

$$\eta_{ex,Tb} = \frac{\dot{W}_{Tb}}{\dot{m}_3(\varepsilon_3 - \varepsilon_4)} \quad (24)$$

Blower

$$\dot{W}_{Bl} = \dot{W}_{Tb} \eta_{Ge} = \dot{m}_{air}(h_b - h_a) \quad (25)$$

$$\dot{E}_{D,Bl} = \dot{m}_{air}(\varepsilon_a - \varepsilon_b) - \dot{W}_{Bl} \quad (26)$$

$$\eta_{ex,Bl} = \frac{\dot{m}_{air}(\varepsilon_a - \varepsilon_b)}{\dot{W}_{Bl}} \quad (27)$$

Deaerator

$$0 = \dot{m}_{16} h_{16} + \dot{m}_{17} h_{17} + \dot{m}_{24} h_{24} + \dot{m}_{25} h_{25} - \dot{m}_{26} h_{26} - \dot{m}_{27} h_{27} \quad (28)$$

$$\dot{E}_{D,De} = \dot{m}_{16} \varepsilon_{16} + \dot{m}_{17} \varepsilon_{17} + \dot{m}_{24} \varepsilon_{24} + \dot{m}_{25} \varepsilon_{25} - \dot{m}_{26} \varepsilon_{26} - \dot{m}_{27} \varepsilon_{27} \quad (29)$$

$$\eta_{e,De} = \frac{\dot{m}_{26} h_{26} + \dot{m}_{27} h_{27}}{(\dot{m}_{16} h_{16} + \dot{m}_{17} h_{17} + \dot{m}_{24} h_{24} + \dot{m}_{25} h_{25})} \quad (30)$$

$$\eta_{ex,De} = \frac{\dot{m}_{26} \varepsilon_{26} + \dot{m}_{27} \varepsilon_{27}}{(\dot{m}_{16} \varepsilon_{16} + \dot{m}_{17} \varepsilon_{17} + \dot{m}_{24} \varepsilon_{24} + \dot{m}_{25} \varepsilon_{25})} \quad (31)$$

RESULTS AND INTERPRETATIONS

The thermal power plant was analyzed for real operating conditions during whole year. The main operating parameters are the turbine supply mass flow rate, HP steam temperature and pressure. In the other hand the seawater temperature varies sensibly for the different seasons in the local region. That may affect the

performances of power plant components supplied by seawater. Hence all the indicated parameters will be taken into consideration for the following analytic study.

A numerical code is established using EES software to perform the calculations required for the thermal and exergy plant analysis. The fluids properties of the different streams are given in Table 2.

Table 2. Fluid properties in the different streams

Stream	m (kg/s)	T (°C)	P (bar)	H (kJ/kg)	S (kJ/kgK)	Ė (kW)
1 Steam	34.17	397	38	3210	6.786	40699
2 Steam	15.55	389	39.65	3188	6.734	18426
3 Steam	3.33	392	37.7	3199	6.772	3946
4 Steam	3.33	50	0.12	2542	7.937	601.9
5 Steam	18.05	386	37.5	3185	6.754	21226
6 Steam	12.5	220	5.64	2895	7.086	9031
7 Steam	5.55	43	0.09	2338	7.422	720.07
8 Steam	0.84	386	37.5	3185	6.754	979.7
9 Steam	0.84	350	5.8	3166	7.562	763.1
10 Steam	22.77	392	37.7	3199	6.772	26967
11 Steam	NO	NO	NO	NO	NO	NO
12 Steam	22.77	250	5.7	2958	7.206	18536
13 Steam	3.34	392	37.7	3199	6.772	3946
14 Steam	3.34	360	12	3186	7.579	3104
15 Steam	3.34	190	12	2790	6.534	3920
16 Water	2.23	99	1	417.4	1.302	168.8
17 Steam	1.95	165	5.7	2773	6.819	1447
17' Steam	9.7	165	5.7	2773	6.819	1447
17'' Water	9.7	54	3	226.1	0.7543	48.72
18 Steam	1.39	165	5.7	2773	6.281	1654
19 Water	8.34	54	3	226.1	0.7543	48.72
20 Steam	14.73	120	1.1	2715	7.42	3542
21 Water	14.73	97	0.92	406.2	1.272	219.1
22 Water	5.55	41	0.08	171.6	0.5852	9.35
23 Water	3.33	40	0.08	167.4	0.5719	4.906
24 Water	38.33	97	1.5	406.3	1.272	1212
25 Water	5	49	2.8	205.2	0.6901	34.15
26 Water	45.55	104	1.2	435.7	1.350	1178
27 Steam	0.55	104	1.1	2683	7.336	278
28 Water	37.5	104	75	443.5	1.351	1697
29 Water	151.01	27	1.013	113.2	0.3951	14162
29' Water	151.01	29	2.7	121.7	0.4228	42526
30 Water	151.01	37	1.5	155	0.5318	159782
31 Water	341.91	27	1.013	113.2	0.3951	14162
31' Water	341.91	29	2.7	121.7	0.4228	171100
32 Water	341.91	33	1.5	138.3	0.4777	171100
33 Water	28.49	29	2.7	121.7	0.4228	8024
34 Water	21.37	50	1.5	209.3	0.703	91.64
a air	66.92	27	1.013	67.26	5.842	5.27
b air	66.92	61	1.331	245.9	6.331	1048
Losses						
Stream	Mass flow rate (kg/s)			Exergy losses (MW)		
HP Steam	1.39			1654.65		
MP Steam	1.11			940.1		
LP Steam	1.39			14.97		

The Irreversibility rates of the different power plant components are presented in Figure 2. The minimum irreversibility rates are obtained for the condensers and deaerators followed by the blowers and turbines. The Steam Turbine Generator STGI presents the maximum irreversibility rates of about 4.1 MW

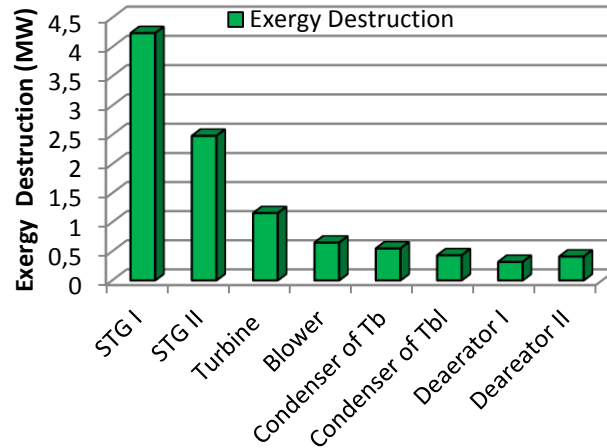

Figure 2. Irreversibility rates of thermal power plant components

The energy and exergy efficiencies are showed in Figure 3. The blower, turbines and deaerators present the better energy efficiencies. The minimum energy efficiencies are obtained for the condensers. The steam turbines and the deaerators present an exergy efficiencies above 62%. The minimum values are obtained for the condensers (20 – 25 %).

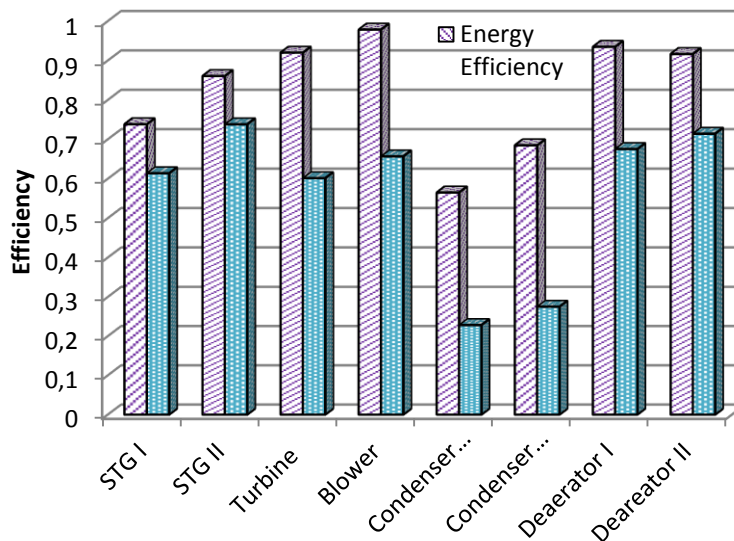

Figure 3. Energetic and exergetic efficiency of main components

The variation of the net power generated by the steam turbine STGI according to HP steam mass flow rate is presented in Figure 4 for different value of condensation rate. The generated power increases gradually with HP steam mass flow rate. One can see that, for HP steam flow rate less than 35 t/h the generated power is not significantly affected by the condensation rate. While this parameter, has a sensible influence on the generated power for HP steam flow rate above 40 t/h. In fact, in this range, increasing the condensate rate leads to the enhancement of the generated power. A maximum net power of about 6 MW is obtained for 20 t/h of condensation rate.

For the back pressure steam turbine STGII, the variation of the net generated power according to HP steam mass flow rate is presented in Figure 5. The generated power increases linearly to achieve about 7 MW for a HP steam mass flow rate of about 82 t/h. The total power generated by the two Steam turbines is widely sufficient for the plant requirements.

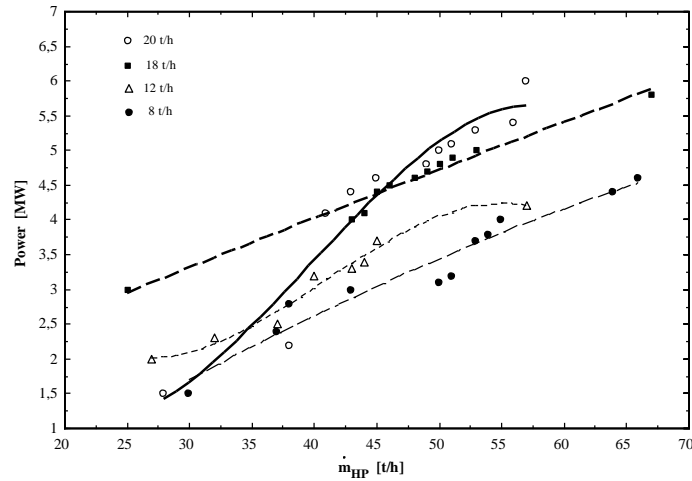

Figure 4. Variation of STGI net power with HP steam flow rate

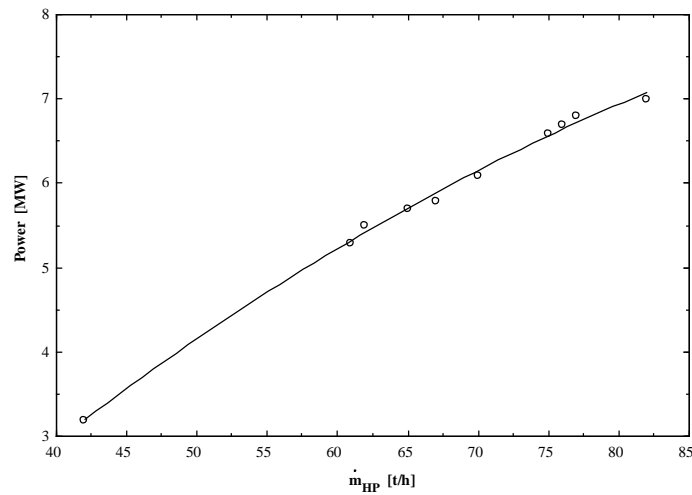

Figure 5. Variation of steam turbine STGII power with HP steam flow rate

The variation of the exergetic efficiency of steam turbine STGI according to HP steam flow rate is presented in Figure 6 for different values of condensate flow rate. The exergy efficiency increases with \dot{m}_{HP} to reach maximum values of about 49%, 51%, 52% and 54% for condensation flow rates of 8, 12, 18 and 20 t/h respectively. The optimum \dot{m}_{HP} values leading to the indicated maximum exergy efficiencies are respectively 55, 46, 52 and 54 t/h.

For the back pressure steam turbine STGII, the variation of the exergetic efficiency according to HP steam mass flow rate is presented in Figure 7. The exergetic efficiency increases sensibly with \dot{m}_{HP} to reach a maximum value of about 75.5 % for a mass flow rate of about 73 t/h. That can be considered as an optimum value for the STGII supply.

Figure 8 illustrates the variation of energy and exergy efficiencies of steam turbines STGI and STGII according to HP steam pressure. For the explored ranges of HP steam pressure, the energy efficiencies of steam turbine generators STGI and STGII increase of about 1.37 % and 8.8 % respectively. While the exergy efficiencies increase of about 2.46 for STGI and 6.8 % for STGII.

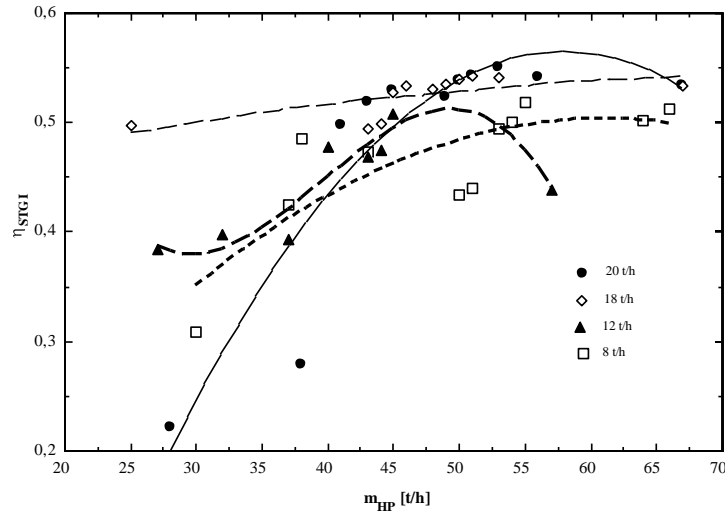

Figure 6. Variation of exergetic efficiency of steam turbine STG I according to HP steam flow rate

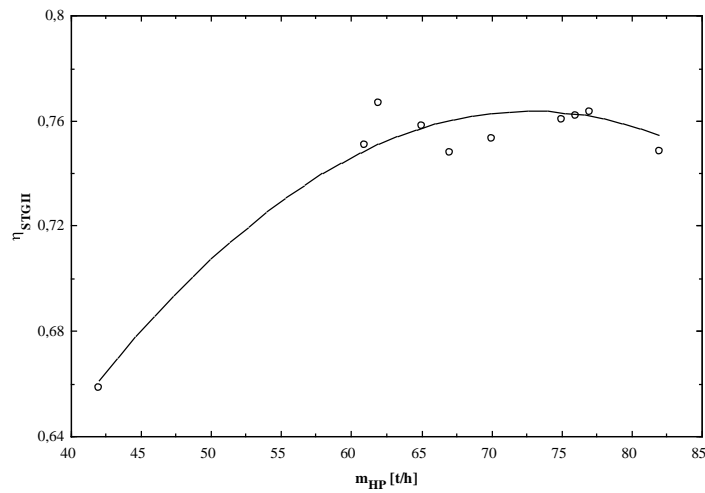

Figure 7. Variation of exergy efficiency of STGII according to HP steam flow rate

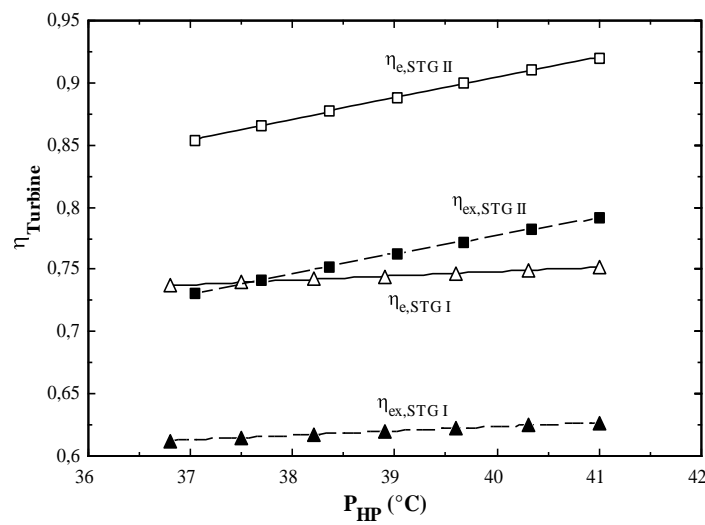

Figure 8. Energetic and exergetic efficiency variations of STGI and STGII according to P_{HP}

The influence of seawater temperature on the condenser irreversibility rates is presented in Figure 9. The irreversibility rates decrease with the increase of T_{sw} . For a seawater temperature variation of 22 °C the

irreversibility rates decrease of about 35 %. Indeed if the T_{sw} increases the temperature difference between the two streams through the condenser decreases too, therefore the irreversibility rate due to temperature gradient I^{AT} decreases. That affects the condenser total irreversibility rate.

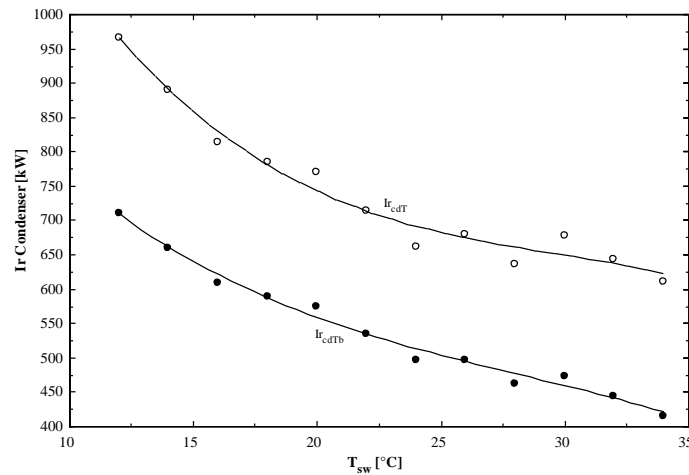

Figure 9. Influence seawater temperature on irreversibility of condensers

Figure 10 depicts the variation of the condenser exergy efficiency according to seawater temperature. It can be seen that increasing the seawater temperature from 12 to 24 °C leads to an increase of the exergy efficiency of about 4 times for the turbo blower condenser and 14 times for the turbine condenser. For T_{sw} above 25 °C the exergy efficiencies increase slightly to reach maximum values of about 35 % and 45 % for the turbine condenser and the turbo-blower condenser respectively. Although the indicated rise of the exergetic efficiency the obtained values are very low especially in cold seasons when the seawater temperature is less than 15 °C. These results agree with I. H. Aljundi investigations [25] on energy and exergy analysis of a steam power plant. In fact the authors obtained the same values of condenser exergy efficiency in similar operating conditions.

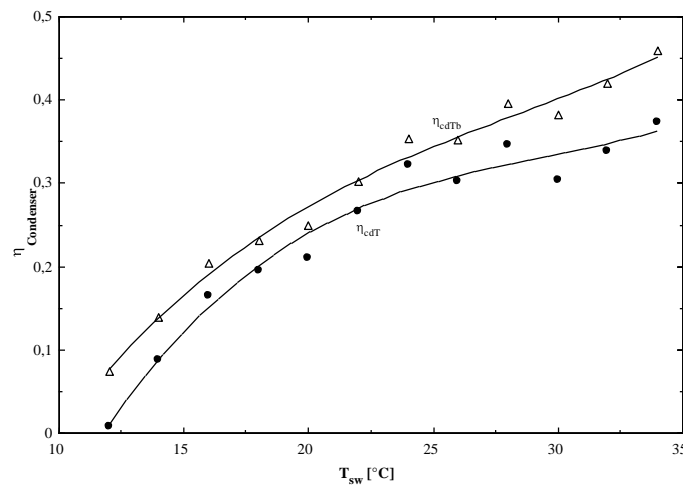

Figure 10. Variation of exergy efficiency of condensers according to seawater temperature

CONCLUDING REMARKS

An Energetic and Exergetic Analysis is conducted on a Steam Turbine Power Plant used in existing Phosphoric Acid Factory. The heat recovery systems used in the different parts of the plant are also considered in the analysis. Mass, thermal and exergy balances are established on the main compounds of the factory. The effects of the key operating parameters such as seawater temperature, and mass flow rate on the cycle performances are investigated. The obtained results can be presented as follows.

The minimum irreversibility rates are obtained for the condensers and deaerators followed by the blowers and turbines. The Steam Turbine Generator STGI presents the maximum irreversibility rates of about 4.1 MW.

For the explored ranges of HP steam pressure, the energy efficiencies of steam turbine generators STGI and STGII increase of about 1.37 % and 8.8 % respectively. While the exergy efficiencies increase of about 2.46 for STGI and 6.8 % for STGII.

About steam mass flow rate effect on net power generated, obtained results show that for STGI and considering condensation mass flow rates of 8, 12, 18 and 20 t/h, the optimum HP steam flow rate values leading to the maximum exergy efficiencies are respectively, 55, 46, 52 and 54 t/h. While for STGII a maximum exergetic efficiency of about 75.5 % is obtained for \dot{m}_{HP} of 73 t/h.

The seawater temperature affects significantly the exergy efficiency of the condensers. That should be taken into consideration for the operating conditions in cold seasons.

The obtained results constitute helpful tools to analyze the real performances of industrial plants and permit to better undertake the future improvements that can be carried out on the different streams in order to improve the efficiency and reduce the energetic losses.

ACKNOWLEDGMENTS

Authors would like to thank the Tunisian Chemical Group for their support and collaboration.

NOMENCLATURE

Bl	Blower
Cp	Specific heat at constant pressure (kJ/kg.K)
CU	Concentration Phosphoric Acid Unit
De	Deaerator
DU	Distillation Unit
\dot{E}	Exergy (kW)
H	Specific Enthalpy (kJ/kg)
HP	High Pressure steam
LP	Low Pressure Steam
MP	Medium Pressure Steam
\dot{m}	Mass flow rate (kg/s)
PAP	Unit of Phosphoric Acid
Ph. A	Phosphoric Acid
R	Gas constant (kJ/kmol.K)
SMM	Sulfur Melting and Maintenance
STGI	Steam Turbine Generator I
STGII	Steam Turbine Generator II
T	Temperature (°C)
Tb	Turbine
TC	Turbine Condenser

Subscripts

0	Reference state
CT	Condenser of Turbine
D	destruction
De	Deaerator
Da	dry air
e	energy
ex	exergy
Ge	Gear
Ha	humid air
in	inlet
out	outlet
Pm	Pump
sw	seawater
v	water vapor
val	valve

Greek letters

ε	specific exergy (kW/kg)
η	efficiency

REFERENCES

- [1] S. Adibhatla, S.C. Kaushik, "Energy and exergy analysis of a super critical thermal power plant at various load conditions under constant and pure sliding pressure operation", *Applied Thermal Engineering*, 2014
- [2] C. J. Koroneos, P. A. Fokaides, E. A. Christoforou, "Exergy analysis of a 300 MW lignite thermoelectric power plant", *Energy*, 2014
- [3] A. Bolatturk, A. Coskun, C. Geredelioglu, "Thermodynamic and exergoeconomic analysis of Cayirhan thermal power plant", *Energy Conversion and Management*, 2015
- [4] A. Atmaca, R. Yumrutaş, "Thermodynamic and exergoeconomic analysis of a cement plant: Part I-Methodology", *Energy Conversion and Management*, 2014
- [5] A. Ghannadzadeh, R. Thery-Hetreux, O. Baudouin, P. Baudet, P. Floquet, X. Joulia, "General methodology for exergy balance in ProSimPlus[®] process simulator", *Energy*, 2012
- [6] M. N. Khan, I. Tlili, W. A. Khan, "Thermodynamic Optimization of New Combined Gas/Steam Power Cycles with HRSG and Heat Exchanger", *Arabian Journal of Science Engineering*, 2017
- [7] G. D. Vučković, M. M. Stojiljković, M. V. Vukić, G. M. Stefanović, E. M. Dedeić, "Advanced exergy analysis and exergoeconomic performance evaluation of thermal process in an existing industrial plant", *Energy Conversion and Management*, 2014
- [8] A. Edge, H. M Şahin, "Determination of uncertainties in energy and exergy analysis of a power plant", *Energy Conversion and Management*, 2014
- [9] J. Taillon, R. E. Blanchard, "Exergy efficiency graphs for thermal power plants", *Energy*, 2015
- [10] L. Anetor, E. E. Osakue, C. Odetunde, "Thermoeconomic Optimization of a 450 MW Natural Gas Burning Steam Power Plant", *Arabian Journal of Science Engineering*, 2016
- [11] O. K. Singh, S.C. Kaushik, "Energy and exergy analysis and optimization of Kalina cycle coupled with a coal fired steam power plant", *Applied Thermal Engineering*, 2013
- [12] T.K. Ray, A. Datta, A. Gupta, R. Ganguly, "Exergy-based performance analysis for proper O&M decisions in a steam power plant", *Energy Conversion and Management*, 2010
- [13] P. Regulagadda, I. Dincer, G. F. Naterer, "Exergy analysis of a thermal power plant with measured boiler and turbine losses", *Applied Thermal Engineering*, 2010
- [14] H. H. Erdem, A.V. Akkaya, B. Cetin, A. Dagdas, S. H. Sevilgen, B. Sahin, I. Teke, C. Gungor, S. Atas, "Comparative energetic and exergetic performance analyses for coal-fired thermal power plants in turkey", *International Journal of Thermal Sciences*, 2009
- [15] F. Molès, "Thermodynamic analysis of a combined organic Rankine cycle and vapor compression cycle system activated with low temperature heat sources using low GWP fluids", *Applied Thermal Engineering*, 2015
- [16] F. Hajabdollahi, Z. Hajabdollahi, H. Hajabdollahi, "Soft computing based multi-objective optimization of steam cycle power plant using NSGA-II and ANN", *Applied Soft Computing*, 2012
- [17] A. Keçebaş, "Energetic, exergetic, economic and environmental evaluations of geothermal district heating systems: An application", *Energy Conversion and Management*, 2013
- [18] A.S. Karakurt, Ü. Güneş, "Performance analysis of a steam turbine power plant at part load conditions", *Journal of Thermal Engineering, Turkey* 2017
- [19] R. Arora, S. C. Kaushik, R. Kumar, "Performance analysis of brayton heat engine at maximum efficient power using temperature dependent specific heat of working fluid", *Journal of Thermal Engineering, Turkey* 2015
- [20] N. Doseva, D. Chakyrova, "Energy and exergy analysis of cogeneration system with biogas engines", *Journal of Thermal Engineering, Turkey* 2015
- [21] A. M. Elsafi, "Exergy and exergoeconomic analysis of sustainable direct steam generation solar power plants", *Energy Conversion and Management*, 2015
- [22] S. Peng, Z. Wang, H. Hong, D. Xu, H. Jin, "Exergy evaluation of a typical 330 MW solar-hybrid coal-fired power plant in China", *Energy Conversion and Management*, 2014

- [23] M. H. K. Manesh, P. Navid, M. Baghestani, S. K. Abadi, M. A. Rosen, A. M. Blanco, M. Amidpour, "Exergoeconomic and exergoenvironmental evaluation of the coupling of a gas fired steam power plant with a total site utility system", *Energy Conversion and Management*, 2014
- [24] A. Ganjehkaviri, M. N. Mohd jaafar, P. Ahmadi, H. Barzegaravval, "Modelling and optimization of combined cycle power plant based on exergoeconomic and environmental analyses", *Applied Thermal Engineering*, 2014
- [25] I. H. Aljundi, "Energy and Exergy analysis of a steam power plant in Jordan", *Applied Thermal Engineering*, 2009